



---

## USER'S MANUAL

# Model 201 and 208 Digital Thermometer

*Includes Coverage For:*

**Model 201 Single-Channel Thermometer**

**Model 208 Eight-Channel Thermometer**



Lake Shore Cryotronics, Inc.  
575 McCorkle Boulevard  
Westerville, Ohio 43082-8888 USA

E-Mail Addresses:

[sales@lakeshore.com](mailto:sales@lakeshore.com)  
[service@lakeshore.com](mailto:service@lakeshore.com)

Visit Our Website:

[www.lakeshore.com](http://www.lakeshore.com)

Fax: (614) 891-1392

Telephone: (614) 891-2243

Methods and apparatus disclosed and described herein have been developed solely on company funds of Lake Shore Cryotronics, Inc. No government or other contractual support or relationship whatsoever has existed which in any way affects or mitigates proprietary rights of Lake Shore Cryotronics, Inc. in these developments. Methods and apparatus disclosed herein may be subject to U.S. Patents existing or applied for. Lake Shore Cryotronics, Inc. reserves the right to add, improve, modify, or withdraw functions, design modifications, or products at any time without notice. Lake Shore shall not be liable for errors contained herein or for incidental or consequential damages in connection with furnishing, performance, or use of this material.

### LIMITED WARRANTY

Lake Shore Cryotronics, Inc. (henceforth Lake Shore), the manufacturer, warrants this product for a period of 12 months from the date of shipment. During the warranty period, under authorized return of instruments or component parts to Lake Shore freight prepaid, the company will repair, or at its option replace, any part found to be defective in material or workmanship, without charge to the Owner for parts, service labor or associated customary shipping cost. Replacement or repaired parts will be warranted for only the unexpired portion of the original warranty.

All products are thoroughly tested and calibrated to published specifications prior to shipment. Calibration Certifications are offered for 6 month periods only. Where such documentation must be updated, a re-certification service is offered by Lake Shore at a reasonable cost.

### LIMITATION OF WARRANTY

This warranty is limited to Lake Shore products purchased and installed in the United States. This same protection will extend to any subsequent owner during the warranty period. It does not apply to damage caused by accident, misuse, fire, flood, or acts of God, from failure to properly install, operate, or maintain the product in accordance with the printed instructions provided. This warranty does not apply to defects resulting from improper or inadequate maintenance, unauthorized modification or misuse, operation outside of the environmental specifications for any product or part or buyer-supplied software interfacing.

THIS WARRANTY IS IN LIEU OF ANY OTHER WARRANTIES, EXPRESSED OR IMPLIED, INCLUDING MERCHANTABILITY OR FITNESS FOR A PARTICULAR PURPOSE, WHICH ARE EXPRESSLY EXCLUDED. THE OWNER AGREES THAT LAKE SHORE'S LIABILITY WITH RESPECT TO THIS PRODUCT SHALL BE SET FORTH IN THIS WARRANTY, AND INCIDENTAL OR CONSEQUENTIAL DAMAGES ARE EXPRESSLY EXCLUDED.

### CERTIFICATION

Lake Shore certifies that this product has been inspected and tested in accordance with its published specifications and that this product met its published specifications at the time of shipment. The accuracy and calibration of this product at the time of shipment are traceable to the United States National Institute of Standards and Technology (NIST); formerly known as the National Bureau of Standards (NBS), or to a recognized natural standard.

### TRADEMARK ACKNOWLEDGEMENT

Manufacturers and sellers claim many designations as trademarks to distinguish their products. Where those designations appear in this manual and Lake Shore was aware of a trademark claim, the designations appear in initial capital letters with a <sup>TM</sup> or <sup>®</sup> symbol.

Apiezon<sup>®</sup> is a trademark of Biddle Instruments.

Cryo-Gloves<sup>®</sup> is a trademark of Tempshield.

Duo-Twist<sup>™</sup>, Quad-Lead<sup>™</sup>, Quad-Twist<sup>™</sup>, and SoftCal<sup>™</sup> are trademarks of Lake Shore Cryotronics, Inc.

Teflon<sup>®</sup> is a trademark of DuPont De Nemours.

Copyright © 1993, 1995, 1997, and 1999 by Lake Shore Cryotronics, Inc. All rights reserved. No portion of this manual may be reproduced, stored in a retrieval system, or transmitted, in any form or by any means, electronic, mechanical, photocopying, recording, or otherwise, without the express written permission of Lake Shore.

## Declaration of Conformity

We:

**Lake Shore Cryotronics, Inc.  
575 McCorkle Blvd.  
Westerville, OH 43082-8888**

Hereby declare that the equipment specified conforms to the following Directives and Standards.

**Application of Council Directives:** 89/336/EEC

**Standards to which  
Conformity is Declared:** EN55022-A  
EN50082-1

**Type of Equipment:** Digital Thermometer

**Model Number:** 201 or 208

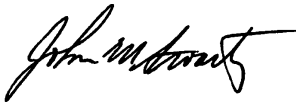

*May 12, 1997*

\_\_\_\_\_  
*Signature*

\_\_\_\_\_  
*Date*

**John M. Swartz  
President**

## Manual Addendum on EMC for the Model 201 or 208

Electromagnetic Compatibility (EMC) of electronic equipment is a growing concern worldwide. Emissions of and immunity to electromagnetic interference is now part of most electronics design and manufacture. To qualify for the CE mark, the Model 201 or 208 meets the generic requirements of the European EMC directive 89/336/EEC as a Class A product. Class A products radiate more RF than Class B products and must include the following warning:

**WARNING: This is a Class A Product. In a domestic environment, this product may cause radio interference in which case the user may be required to take adequate measures.**

The instrument was tested under normal operating conditions with sensor and interface cables attached. If the installation and operating instructions in the User's Manual are followed there should be no degradation in EMC performance.

Pay special attention to instrument cabling. Improperly installed cabling may defeat even the best EMC protection. For the best performance from any precision instrument, follow the grounding and shielding instructions in the User's Manual. In addition, the installer of the Model 201 or 208 should consider the following:

- Leave no unused or unterminated cables attached to the instrument.
- Make cable runs as short and direct as possible.
- Do not tightly bundle cables that carry different types of signals.
- Add the clamp-on ferrite filter (part number 109-053) included with the connector kit to the serial interface cable near the instrument rear panel when that interface is used.

## TABLE OF CONTENTS

<i>Chapter/Paragraph</i>	<i>Title</i>	<i>Page</i>
<b>1</b>	<b>INTRODUCTION.....</b>	<b>1-1</b>
1.0	General .....	1-1
1.1	System Description .....	1-1
1.2	Safety Summary.....	1-4
1.3	Safety Symbols .....	1-5
<b>2</b>	<b>INSTALLATION.....</b>	<b>2-1</b>
2.0	General .....	2-1
2.1	Inspection and Unpacking.....	2-1
2.2	Repackaging For Shipment.....	2-1
2.3	Power and Ground Requirements.....	2-2
2.4	Sensor Installation Recommendations .....	2-3
2.4.1	Two-Lead Vs. Four-Lead Measurements .....	2-3
2.4.1.1	Four-Lead Measurements .....	2-4
2.4.1.2	Two-Lead Measurements .....	2-4
2.4.2	Connecting Leads to the Sensor .....	2-4
2.4.3	Sensor Mounting .....	2-5
2.4.4	Measurement Errors Due To AC Noise .....	2-6
2.5	Sensor Input Connections.....	2-7
2.6	Sensor Curve Definition .....	2-9
2.7	Rack Mounting .....	2-9
2.8	Initial Power Up Sequence.....	2-11
2.9	Power Up Errors.....	2-11
<b>3</b>	<b>OPERATION.....</b>	<b>3-1</b>
3.0	General .....	3-1
3.1	Units Key.....	3-1
3.2	Channel Key (Model 208 Only) .....	3-1
3.3	Scan Mode .....	3-1
3.4	Setting Dwell Times .....	3-2
3.5	Alarm Operation .....	3-3
3.5.1	Alarm Setpoint.....	3-3
3.5.2	Latched and Unlatched Alarms .....	3-4
3.5.3	Alarm Fix Function (Model 208 Only) .....	3-4
3.6	SoftCal Compensations .....	3-4
3.6.1	SoftCal Calibration.....	3-5
3.6.2	Verifying SoftCal Operation .....	3-6
3.6.3	Erasing SoftCal Compensations.....	3-6

## TABLE OF CONTENTS (Continued)

<i>Chapter/Paragraph</i>	<i>Title</i>	<i>Page</i>
<b>4</b>	<b>REMOTE OPERATION.....</b>	<b>4-1</b>
4.0	General .....	4-1
4.1	Serial Interface .....	4-1
4.1.1	Serial Interface Connections .....	4-1
4.1.2	Serial Interface Operation.....	4-3
4.1.3	Sample Basic Program.....	4-4
4.1.4	Sample QuickBasic 4.0 Program.....	4-4
4.2	Serial Interface Command Summary .....	4-5
<b>5</b>	<b>SERVICE .....</b>	<b>5-1</b>
5.0	General .....	5-1
5.1	Model 201 Rear Panel Connections.....	5-1
5.2	Model 208 Rear Panel Connections.....	5-2
5.3	Error Code Troubleshooting .....	5-3
5.4	General Maintenance .....	5-4
5.5	Fuse Replacement .....	5-4
5.6	Line Voltage Configuration .....	5-4
5.7	Recalibration .....	5-5
5.7.1	Current Source Calibration .....	5-6
5.7.2	A/D Converter Calibration.....	5-6
5.8	Serial Interface Cable and Adapters .....	5-7
<b>6</b>	<b>OPTIONS AND ACCESSORIES .....</b>	<b>6-1</b>
6.0	General .....	6-1
6.1	Models.....	6-1
6.2	Accessories.....	6-1
6.3	Wires.....	6-3
6.4	Sensors .....	6-3
<b>APPENDIX A – GLOSSARY OF TERMINOLOGY .....</b>		<b>A-1</b>
<b>APPENDIX B – HANDLING OF LHe &amp; LN<sub>2</sub>.....</b>		<b>B-1</b>
B1.0	General .....	B-1
B2.0	Properties.....	B-1
B3.0	Handling Cryogenic Storage Dewars .....	B-1
B4.0	LHe and LN <sub>2</sub> Safety Precautions .....	B-1
B5.0	Recommended First Aid.....	B-2
<b>APPENDIX C – CURVE TABLES.....</b>		<b>C-1</b>
C1.0	General .....	C-1

## LIST OF ILLUSTRATIONS

<i>Figure No.</i>	<i>Title</i>	<i>Page</i>
1-1	Model 201 Front Panel.....	1-2
1-2	Model 208 Front Panel.....	1-2
1-3	Model 2308-12 Case Physical Dimensions .....	1-10
2-1	Model 201 Sensor Connector J1 Details .....	2-7
2-2	Model 208 Sensor Connector J1 Details .....	2-8
2-3	Model 2090 Rack Mounting .....	2-10
3-1	Model 201 Front Panel.....	3-2
3-2	Model 208 Front Panel.....	3-2
4-1	Serial I/O (RJ-11) Connector Pin Definitions .....	4-2
4-2	Serial Interface Connections.....	4-2
5-1	Model 201 Rear Panel Connections .....	5-1
5-2	Model 208 Rear Panel Connections .....	5-2
5-3	Line Voltage Jumper Configuration .....	5-5
5-4	Calibration Connections.....	5-6
5-5	Model 2001 RJ-11 Cable Assembly Wiring Details .....	5-7
5-6	Model 2002 RJ-11 to DB-25 Adapter Wiring Details .....	5-7
5-7	Model 2003 RJ-11 to DB-9 Adapter Wiring Details .....	5-8
6-1	Model 2001 RJ-11 Cable Assembly.....	6-4
6-2	Model 2002 RJ-11 to DB-25 Adapter.....	6-4
6-3	Model 2003 RJ-11 to DB-9 Adapter.....	6-5

## LIST OF TABLES

<i>Table No.</i>	<i>Title</i>	<i>Page</i>
1-1	Model 201/208 Specifications.....	1-3
2-1	Line Voltage and Fuse Rating Selection.....	2-2
2-2	Model 201/208 Temperature Curves .....	2-9
4-1	Serial Interface Specifications .....	4-1
B-1	Comparison of LHe to LN <sub>2</sub> .....	B-1
C-1	Curve 0 - DT-500DI-8B Voltage-Temp. Characteristics.....	C-1
C-2	Curve 1 - DT-500DI-8A Voltage-Temp. Characteristics.....	C-2
C-3	Curve 2 - DT-500DRC-D Voltage-Temp. Characteristics .....	C-3
C-4	Curve 3 - DT-500DRC-E1 Voltage-Temp. Characteristics.....	C-4
C-5	Curve 4 - CTI Diode Voltage-Temp. Characteristics.....	C-5
C-6	Curve 5 - DT-500DI-8C Voltage-Temp. Characteristics.....	C-6
C-7	Curve 6 - DT-470 Voltage-Temp. Characteristics.....	C-7

This Page Intentionally Left Blank



# CHAPTER 1

## INTRODUCTION

### 1.0 GENERAL

This chapter provides an introduction to the Model 201/208 Digital Thermometer. The Model 201/208 was designed and manufactured in the United States of America by Lake Shore Cryotronics. A general description is provided in Paragraph 1.1, safety summary in Paragraph 1.2, and safety symbols in Paragraph 1.3.

If you have just received your new Model 201/208, please proceed to Chapter 2 and become familiar with the installation instructions. Complete and detailed instrument and sensor operational information is contained in Chapter 3. Remote operation is outlined in Chapter 4. Limited service and rear panel connector definitions are contained in Chapter 5. Chapter 6 provides information on options and accessories. Appendix A is a Glossary of Terminology. Handling of Liquid Helium and Liquid Nitrogen is provided in Appendix B. Finally, details on sensor curves are provided in Appendix C.

### 1.1 GENERAL DESCRIPTION

The Model 201/208 Digital Thermometers are ideal for monitoring critical temperature conditions in areas such as chemical investigation, materials research, superconductivity measurements, and in low temperature physics. The units feature:

- Broad Temperature Range: 1.4 K to 475 K (–272 °C to 202 °C).
- Single Channel (201) and Eight Channel (208) Models.
- For Use with Lake Shore DT-470 Series, DT-500 Series, and other Silicon Diode Sensors.
- System Accuracy (Instrument with Sensor) with SoftCal™ to within  $\pm 0.1$  °C or better.
- Displays Temperature in °C, °F, or K, or in Sensor Voltage.
- High/Low Alarm Setpoint with Interfacing Alarm Contacts.
- Standard RS-232C Output of Temperature, Input of Settings, and Alarm Status For Remote Operation.

**General Description (Continued)**

The Model 201 and 208 provide a usable temperature range not attainable in many other digital thermometers. Combined with Lake Shore DT-470 and DT-471 Series silicon diode temperature sensors, the digital thermometers provide repeatable, accurate measurements from nearly 0 Kelvin to well above room temperature.

All Lake Shore DT-470 and DT-471 Series Sensors follow the same temperature response curve (Curve 10). Five bands of tracking accuracy are offered so that sensor selection can be made with both technical and economic considerations for a given application.

The eight channel Model 208 features a user-programmable scan/dwell operation mode with dwell times of 0 (skip), 5, 10, 30 or 60 seconds.

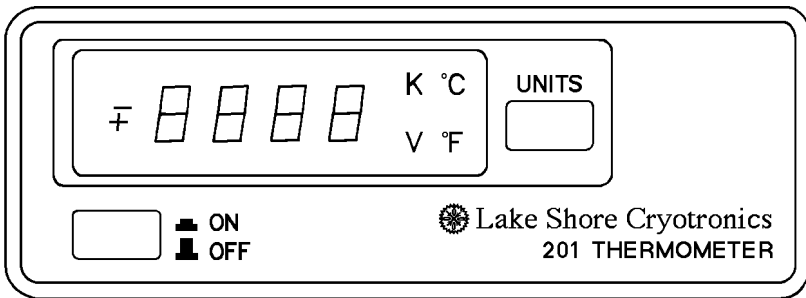

P-201-1-1.bmp

**Figure 1-1. Model 201 Front Panel**

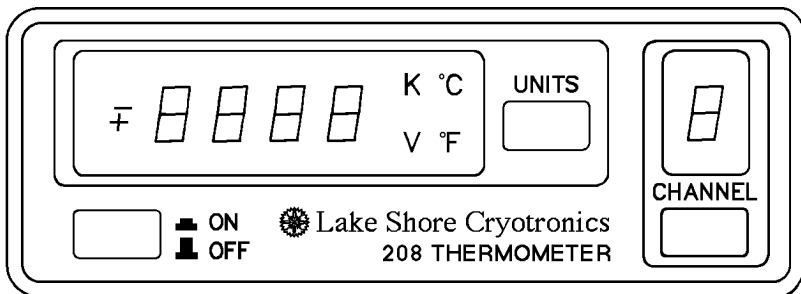

P-201-1-2.bmp

**Figure 1-2. Model 208 Front Panel**

**Table 1-1. Model 201/208 Specifications**

Display: Four-digit LED display

Resolution: 0.1 for values > 100 or < -100  
0.01 for values between -100 < T < 100

Temperature Range: 1.4 K to 475 K without probe  
23 K to 473 K with probe

System Accuracy: To within  $\pm 0.1$ K in the range of 177 K to 313 K.  
To  $\pm 0.2$  K or better over range of 30 K to 373 K.  
Above 373 K, accuracy will be  $\pm 1.0$  K.

Sensor Excitation: 10  $\mu$ A constant current

Repeatability: <50 mK

Input Range: 0 to 3 volts with a resolution of 0.1 millivolts

Hi/Lo Alarm Setpoint: 0.1° resolution

Alarm Relay: Single SPDT relay, rated 28 VDC or Peak AC, 0.25 A  
(3 W max.)

Scan/Dwell: The Model 208 automatically scans all eight channels  
with selectable dwell times of 0 (skip), 5, 10, 30 and 60  
seconds for each channel.

Connections: Sensor connection is 4-lead (2 current and 2 voltage)

Response Curves\*: Standard Curve 10  
DT-500DI-8A (also -8B and -8C)  
DT-500DRC-D  
DT-500DRC-E1  
CTI Curve C

\* SoftCal works only with DT-470/471 diode sensors.

### COMPUTER INTERFACE

Type: RS-232C Serial 3-Wire (Refer to Table 4-1 for details.)

### MECHANICAL

Ambient Temperature Range: 18–28 °C (64–82 °F), or  
15–35 °C (59–95 °F) with reduced accuracy

Power Requirements: 90–125 or 210–250 VAC, 50/60 Hz, 3 watts

Dimensions: 41 mm High  $\times$  106 mm Wide  $\times$  164 mm Deep  
(1.6 inches  $\times$  4.2 inches  $\times$  6.5 inches)

Weight: 0.5 kilogram (1.1 Pounds)

### NOTES:

1. Product specifications are subject to change without notice.
2. Electronic temperature accuracy of the system in a given temperature range is the sum of the specifications given for input and output. Sensor calibration errors are not included.

## 1.2 SAFETY SUMMARY

The following general safety precautions must be observed during all phases of operation, service, and repair of this instrument. Failure to comply with these precautions or with specific warnings elsewhere in this manual violates safety standards of design, manufacture, and intended use of the instrument. Lake Shore Cryotronics, Inc. assumes no liability for the customer's failure to comply with these requirements.

### **Ground The Instrument**

To minimize shock hazard, the instrument chassis and cabinet must be connected to an electrical ground. The instrument is equipped with a three-conductor AC power cable. The power cable must either be plugged into an approved three-contact electrical outlet or used with a three-contact adapter with the grounding wire (green) firmly connected to an electrical ground (safety ground) at the power outlet. The power jack and mating plug of the power cable meet Underwriters Laboratories (UL) and International Electrotechnical Commission (IEC) safety standards.

### **Do Not Operate In An Explosive Atmosphere**

Do not operate the instrument in the presence of flammable gases or fumes. Operation of any electrical instrument in such an environment constitutes a definite safety hazard.

### **Keep Away From Live Circuits**

Operating personnel must not remove instrument covers. Component replacement and internal adjustments must be made by qualified maintenance personnel. Do not replace components with power cable connected. To avoid injuries, always disconnect power and discharge circuits before touching them.

### **Do Not Substitute Parts Or Modify Instrument**

Because of the danger of introducing additional hazards, do not install substitute parts or perform any unauthorized modification to the instrument. Return the instrument to an authorized Lake Shore Cryotronics, Inc. representative for service and repair to ensure that safety features are maintained.

### 1.3 SAFETY SYMBOLS



Product will be marked with this symbol in order to protect against damage to the instrument.



Indicates dangerous voltage (terminals fed by voltage over 1000 volts must be so marked).

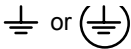

Protective conductor terminal. For protection against electrical shock in case of a fault. Used with field wiring terminals to indicate the terminal which must be connected to ground before operating equipment.



Low-noise or noiseless, clean ground (earth) terminal. Used for a signal common, as well as providing protection against electrical shock in case of a fault. A terminal marked with this symbol must be connected to ground in the manner described in the installation (operating) manual, and before operating equipment.

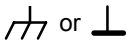

Frame or chassis terminal. A connection to the frame (chassis) of the equipment which normally includes all exposed metal structures.



Alternating current (power line).



Direct current (power line).



Alternating or direct current (power line).

This Page Intentionally Left Blank

## CHAPTER 2

# INSTALLATION

### 2.0 GENERAL

This chapter provides installation instructions for the Model 201/208 Digital Thermometer. Inspection and unpacking instructions are provided in Paragraph 2.1, repackaging for shipment in Paragraph 2.2, sensor installation recommendations in Paragraph 2.3, power and ground requirements in Paragraph 2.4, sensor curve definitions in Paragraph 2.5, and rack mounting details in Paragraph 2.6.

### 2.1 INSPECTION AND UNPACKING

Inspect shipping containers for external damage. Claims for damage (apparent or concealed) or partial loss of shipment must be made in writing to Lake Shore within 5 days from receipt of goods. If damage or loss is apparent, please notify the shipping agent immediately.

Open the shipping container. A packing list is included with the instrument to simplify checking that the unit, sensor, accessories, and manual were received. Please use the packing list and the spaces provided to check off each item as the instrument is unpacked. Inspect for damage. Be sure to inventory all components supplied before discarding any shipping materials. If there is damage to the instrument in transit, be sure to file proper claims promptly with the carrier and insurance company. Please advise Lake Shore Cryotronics of such filings. In case of parts or accessory shortages, advise Lake Shore immediately. Lake Shore cannot be responsible for any missing parts unless notified within 60 days of shipment.

### 2.2 REPACKAGING FOR SHIPMENT

If it is necessary to return the Model 201/208, sensors, or accessories for repair or replacement, a Return Goods Authorization (RGA) number must be obtained from a factory representative before returning the instrument to our service department. When returning an instrument for service, the following information must be provided before Lake Shore can attempt any repair.

1. Instrument model and serial number.
2. User's name, company, address, and phone number.
3. Malfunction symptoms.
4. Description of system.
5. Returned Goods Authorization (RGA) number.

If possible, the original packing material should be retained for reshipment. If not available, consult Lake Shore for shipping and packing instructions.

## 2.3 POWER AND GROUND REQUIREMENTS

The Model 201/208 requires a power source of 90–125 or 210–250 VAC, 50 or 60 Hz, single phase, 3 Watts. A three-prong detachable power cord for 120 VAC operation is included. Connect to rear panel UL/IEC/ICEE standard plug. The fuse rating is defined in Table 2-1.

**WARNING:** To prevent electrical fire or shock hazards, do not expose this instrument to rain or excess moisture.

**CAUTION:** Verify that the AC Line Voltage Selection Wheel located on the rear panel of the Model 201/208 is set to the available AC line voltage and that the proper fuse is installed before inserting the power cord and turning on the instrument. To change voltage configuration, refer to Chapter 5.

**NOTE:** Do not attach the shield to earth ground at the sensor end or noise may be introduced at the measurement end.

**Table 2-1. Line Voltage and Fuse Rating Selection**

Select	Range	Fuse
115	90–125 VAC	0.2 A (Slow Blow)
230	210–250 VAC	0.1 A (Slow Blow)

To protect operating personnel, the National Electrical Manufacturer's Association (NEMA) recommends, and some local codes require, instrument panels and cabinets be grounded. This instrument is equipped with a three-conductor power cable which, when plugged into an appropriate receptacle, grounds the instrument.

Grounding and shielding of signal lines are major concerns when setting up any precision instrument or system. The 201/208 has included ground isolation of the sensor excitation to allow 4-wire measurement of diode voltage and resistance. Improper grounding of sensor leads and shields can defeat this feature.

Digital logic in the Model 201/208 is tied directly to earth ground for interface communication. The low side of the heater output is directly connected to earth ground.

Shield sensor cables whenever possible. Attach the shields to the shield pin provided in the connector.



## **2.4 SENSOR INSTALLATION RECOMMENDATIONS**

Abbreviated diode sensor installation recommendations for the Model 201/208 are included in this paragraph. Please refer to the Lake Shore Product Catalog for installation details and sensor specifications. Call Lake Shore for copies of application notes or with questions or comments concerning sensor installation.

The following are general recommendations on sensor installation:

1. Do not ground the sensor.
2. Shield the leads and connect the shield wire to SHIELD on the screw terminal connector only. Do not connect shield at the other end of the cable.
3. Keep leads as short as possible.
4. Use twisted-pair wire. Use of Lake Shore Duo-Twist™ wire (or equivalent) for two-wire, or Quad-Twist™ wire (or equivalent) for four-wire applications, is strongly recommended.
5. Lead wires should be thermally anchored.

Paragraph 2.4.1 discusses two-lead versus four-lead measurements. Paragraph 2.4.2 discusses connecting leads. Sensor mounting is covered in Paragraph 2.4.3. Finally, Paragraph 2.4.4 describes the effect of measurement errors due to AC noise.

### **2.4.1 Two-Lead Versus Four-Lead Measurements**

In the two lead measurement scheme, the leads used to measure the sensor voltage are also the current carrying leads. The resultant voltage measured at the instrument is the sum of the temperature sensor voltage and the IR voltage drop within the two current leads. Since in a cryogenic environment, the flow of heat down the leads can be of critical concern, normally wire of small diameter and significant resistance per foot is preferred to minimize this heat flow. Consequently, a voltage drop within the leads can be present.

In a four-lead measurement scheme, the current is confined to one pair of current leads with the sensor voltage measured using the remaining lead pair which is not carrying current.

### 2.4.1.1 Four-Lead Measurements

All sensors, including both two-lead and four-lead devices, can be measured in a four-lead configuration to eliminate the effects of lead resistance. The exact point at which the connecting leads are soldered to the two-lead sensor normally results in a negligible temperature uncertainty.

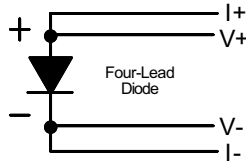

### 2.4.1.2 Two-Lead Measurements

Sometimes system constraints dictate the use of two-lead measurements. Connect the positive terminals (V+ and I+) together and the negative terminals (V- and I-) together at the instrument, then run two leads to the sensor.

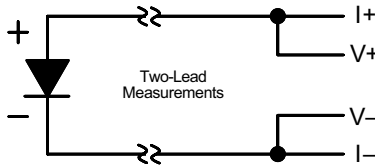

Some loss in accuracy can be expected since the voltage measured at the voltmeter becomes the sum of the sensor voltage and the voltage drop across the connecting leads. The exact measurement error will depend on sensor sensitivity and variations resulting from changing temperature. For example, a  $10\ \Omega$  lead resistance will result in a 0.1 mV voltage error. The resultant temperature error at liquid helium temperature is only 3 mK, but, because of the lower sensitivity ( $dV/dT$ ) of the diode at higher temperatures, it becomes 10 mK at liquid nitrogen temperature.

### 2.4.2 Connecting Leads To The Sensor

An excessive heat flow through the connecting leads to any temperature sensor can create a situation where the active sensing element is at a different temperature than the sample to which the sensor is mounted. This is then reflected as a real temperature offset between what is measured and the true sample temperature. Such temperature errors can be eliminated by proper selection and installation of the connecting leads.

### Connecting Leads To The Sensor (Continued)

In order to minimize any heat flow through the leads, the leads should be of small diameter and low thermal conductivity. Phosphor-bronze or Manganin wire is commonly used in sizes 32 or 36 AWG. These wires have a fairly low thermal conductivity yet the electrical resistivities are not so large as to create any problems in measurements.

Lead wires should also be thermally anchored at several temperatures between room temperature and cryogenic temperatures to guarantee that heat is not being conducted through the leads to the sensor.

### 2.4.3 Sensor Mounting

Before installing a diode sensor, identify which lead is the anode and which is the cathode. When viewed with the base down and with the leads towards the observer, the positive lead (anode) is on the right and the negative lead (cathode) is on the left. The Lake Shore DT-470-SD silicon diode sensor lead configuration is shown below. For other sensors, read the accompanying literature or consult the manufacturer to ensure positive identification of sensor leads. Be sure the lead identification remains clear even after installation of the sensor. It is also a good idea to record the serial number and location of the sensor.

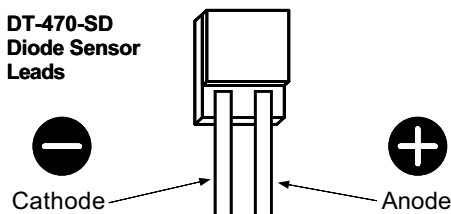

On the DT-470-SD, the base is the largest flat surface. It is sapphire with gold metalization over a nickel buffer layer. The base is electrically isolated from the sensing element and leads, and all thermal contact to the sensor should be made through the base. A thin braze joint around the sides of the SD package is electrically connected to the sensing element. Contact to the sides with any electrically conductive material must be avoided.

When installing the sensor, make sure there are no electrical shorts or current leakage paths between the leads or between the leads and ground. If IMI-7031 varnish or epoxy is used, it may soften varnish-type lead insulations so that high resistance shunts appear between wires if *sufficient time for curing is not allowed*.

### Sensor Mounting (Continued)

Teflon® spaghetti tubing is useful for sliding over bare leads when the possibility of shorting exists. Also, avoid putting stress on the device leads and allow for the thermal contractions that occur during cooling which could fracture a solder joint or lead if installed under tension at room temperature.

For temporary mounting in cold temperature applications, a thin layer of Apiezon® N Grease should be used between the sensor and sample to enhance the thermal contact under slight pressure. The preferred method for mounting the DT-470-SD sensor is the Lake Shore CO Adapter.

**CAUTION:** Lake Shore will not warranty replace any device damaged by a user-designed clamp or damaged by solder mounting.

If semi-permanent mountings are desired, the use of Stycast epoxy can replace the use of Apiezon N Grease.

**NOTE:** Do not apply Stycast epoxy over the DT-470-SD package. Stress on the sensor can cause shifts in the readings.

In all cases, the mounting of the sensor should be periodically inspected to verify that good thermal contact to the mounting surface is maintained.

#### 2.4.4 Measurement Errors Due To AC Noise

Poorly shielded leads or improperly grounded measurement systems can introduce AC noise into the sensor leads. For diode sensors, the effect of the AC noise appears as a shift in the DC voltage measurement due to the non-linear current/voltage characteristics of the diode. When this occurs, the DC voltage measured will be too low and the corresponding temperature indication will be high. The resulting measurement error can approach several tenths of a kelvin.

To determine if this is a problem in your measurement system, perform either of the two following procedures.

1. Place a capacitor across the diode to shunt the induced AC currents. The size of the capacitor used will depend on the frequency of the noise. If the noise is related to the power line frequency, use a 10  $\mu\text{F}$  capacitor. If AC-coupled digital noise is suspected (digital circuits or interfaces), then use a capacitor in the range of 0.1 to 1  $\mu\text{F}$ . In either case, if the resultant DC voltage measured is observed to increase, there is induced noise in your measurement system.

**Measurement Errors Due To AC Noise (Continued)**

2. Measure the AC voltage across the diode with an AC voltmeter or oscilloscope. Note that most voltmeters will not have the frequency response to measure noise associated with digital circuits or interfaces (which operate in the MHz range). A thorough discussion of this potential problem, and the magnitude of error which may result, is given in the paper "Measurement System-Induced Errors In Diode Thermometry," J.K. Krause and B.C. Dodrill, Rev. Sci. Instr. 57 (4), 661, April, 1986; which is available from Lake Shore upon request.

The potential for this type of error can be greatly reduced by connecting twisted leads (pairs) between the measurement instruments and the diode sensors when an AC noise environment exists. We recommend the use of Duo-Twist™ Cryogenic Wire, which features phosphor bronze wire, 32 or 36 AWG, twisted at 3.15 twists per centimeter (8 twists per inch). Duo-Twist wire is available from Lake Shore. Refer to the Lake Shore Product Catalog or contact Lake Shore for further information.

**2.5 SENSOR INPUT CONNECTIONS**

The Model 201 has one rear panel 4-pin sensor input connector designated J1 INPUT 1. The connector pins, numbered 1 thru 4, are shown in Figure 2-1.

**J1 INPUT 1**

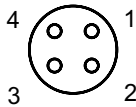

C-201-2-1.eps

Terminal	Description
4	+ Current Out
1	- Current Out
2	- Voltage Sense
3	+ Voltage Sense
Case	Shield

**Figure 2-1. Model 201 Sensor Connector J1 Details**

**Sensor Input Connections (Continued)**

The Model 208 has a 36-pin Miniature-D style connector designated J1 INPUTS for inputs 1 thru 8. A Model 208-D connector is included to solder interfacing connections to J1. The pin configuration of the Model 208-D is shown in Figure 2-2.

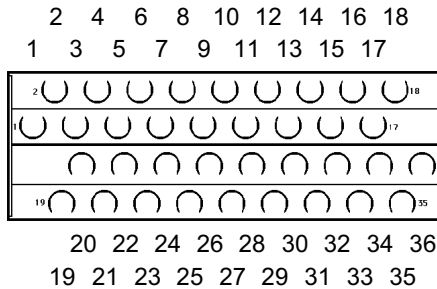

C-201-2-2.eps

Terminal	Description	Input
1	+V	1
2	-V	1
3	+V	2
4	-V	2
5	+V	3
6	-V	3
7	+V	4
8	-V	4
9	+V	5
10	-V	5
11	+V	6
12	-V	6
13	+V	7
14	-V	7
15	+V	8
16	-V	8
17	Shield	—
18	Shield	—

Terminal	Description	Input
19	+I	1
20	-I	1
21	+I	2
22	-I	2
23	+I	3
24	-I	3
25	+I	4
26	-I	4
27	+I	5
28	-I	5
29	+I	6
30	-I	6
31	+I	7
32	-I	7
33	+I	8
34	-I	8
35	Shield	—
36	Shield	—

**Figure 2-2. Model 208-D Sensor Connector Details**

## 2.6 SENSOR CURVE DEFINITION

In order for the instrument to display accurate temperature, a response curve that matches the sensor being used must be selected. Seven standard curves are stored within the Model 201/208. Different curves may be assigned to each channel of the Model 208. The curves are numbered 0 through 6 and are detailed in Appendix C. The curve the unit is configured for is listed on the inside of the front cover. Curve 6 (DT-470 Curve 10) is the standard curve which will be selected unless specified differently upon ordering.

To determine which curve is selected, press and hold the UNITS key and turn on (1) the rear panel SET switch (DIP switch 3). Release the UNITS key. The 201 will now display the curve number in the display window. The Model 208 will display the curve number in the display window and the channel number in the channel window. In order to display curves for the other channel numbers in the Model 208, simply press the CHANNEL key and scroll through the eight channels.

To change the curve, press the UNITS key. The instrument will scroll through curves 0 through 6. In the Model 208, press the CHANNEL key to select additional channels for curve selection. Then, simply press the UNITS key to scroll through the curves.

After the new curve is selected, turn the SET switch on the rear panel back off (0). The unit will now return to normal operation.

**Table 2-2. Model 201/208 Temperature Curves**

Curve No.	Range (K)	Description
0	0 – 324.9	DT-500DI-8B
1	0 – 324.9	DT-500DI-8A
2	0 – 324.9	DT-500DRC-D
3	0 – 324.9	DT-500TDC-E1
4	0 – 324.9	CTI Curve C
5	0 – 324.9	DT-500DI-8C
6	0 – 474.9	DT-470 Curve 10

## 2.7 RACK MOUNTING

The Models 201 and 208 can be installed in a standard size ¼ panel EIA rack space. If you have ordered a 2090 rack mounting adapter, use the following instructions for installation. See Figure 2-3.

1. Remove the front feet on the bottom of the unit and attach the lower rack piece using the threaded holes with two of the four screws provided.
2. Locate the two mounting hole access covers on the top of the unit. Attach the other rack

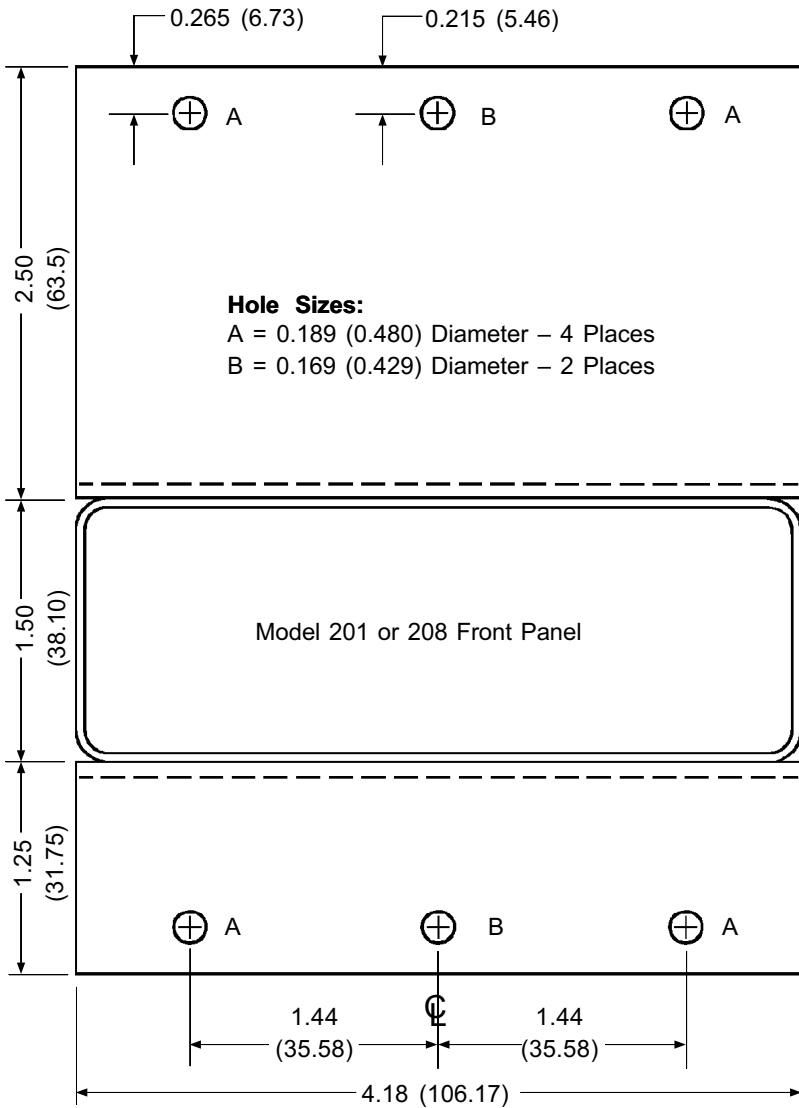

C-201-2-3.eps

**Figure 2-3. Model 2090 Rack Mounting**



## 2.8 INITIAL POWER UP SEQUENCE

The following test sequence occurs at power up.

1. All display segments are lighted.
2. The unit displays “-201-” or “-208-.”
3. The instrument then begins normal operation. The Units selected will flash. Model 208s also indicate the selected channel.

## 2.9 POWER UP ERRORS

On power up, the 201/208 does a check of the internal memory. In the event that a problem exists, an error message will be displayed on the instrument's front panel.

“**ERO1**” on the display, indicates that there is a hardware problem in the instrument's memory. This error is not correctable by the user and the factory should be consulted.

“**ERO2**” on the display indicates that there is a soft error in the instrument's memory. This error can be corrected by closing dip switch 1 on the rear panel for at least 5 seconds. Then, put the switch in the open position. You must follow the calibration procedure described in Paragraph 5.3 after an error 2 has been reset.

“**OL**” means overload, indicating the voltage input is too high. This can be caused by an open sensor or diode sensor wired backwards.

This Page Intentionally Left Blank

## CHAPTER 3

# OPERATION

### 3.0 GENERAL

This chapter describes operation of the Model 201/208 Digital Thermometer. Units key operation is provided in Paragraph 3.1, Channel key (Model 208 only) in Paragraph 3.2, scan mode in Paragraph 3.3, setting dwell times in Paragraph 3.4, alarm operation in Paragraph 3.5, SoftCal compensations in Paragraph 3.6, calibration in Paragraph 3.7, verifying SoftCal operation in Paragraph 3.8, and erasing SoftCal compensations in Paragraph 3.9.

### 3.1 UNITS KEY

The UNITS key selects the different units of measurement. The thermometer reads in voltage or temperature (kelvin, Celsius, or Fahrenheit). Press the UNITS key to scroll through the various selections.

The UNITS key is also used to determine if the SoftCal feature is active. Press and hold the UNITS key for 3 seconds. If SoftCal is not active, "- 000-" will appear in the display.

### 3.2 CHANNEL KEY (MODEL 208 ONLY)

This key scrolls through the eight possible sensor channels.

The Channel key is also used to determine if Scan mode is activated. Press and hold 1 to 2 seconds to toggle the scan mode on or off. A red light will glow in the upper left channel display if the scan mode is active.

### 3.3 SCAN MODE

The thermometer can scan 8 channels or monitor 1 channel. To enable scan mode, press the CHANNEL key for more than 1 but less than 2 seconds. If a light appears in the upper left of the channel display window, then the thermometer is in SCAN mode. If the light does not appear, the thermometer is in single-channel mode. CHANNEL key is a toggle. Repeat action to reverse mode.

### 3.4 SETTING DWELL TIMES

The time the thermometer pauses on each channel (dwell) can be set for 5, 10, 30, or 60 seconds. A dwell time of 0 instructs the thermometer to skip that particular channel. To set the dwell:

1. Hold the CHANNEL key 3 for seconds. Do not release.
2. After 3 seconds, while still pressing CHANNEL, use the UNITS key to select the desired time; 0 (skip), 5, 10, 30, or 60 seconds.
3. Repeat the procedure for each desired channel. The default channel dwell is 5 seconds.

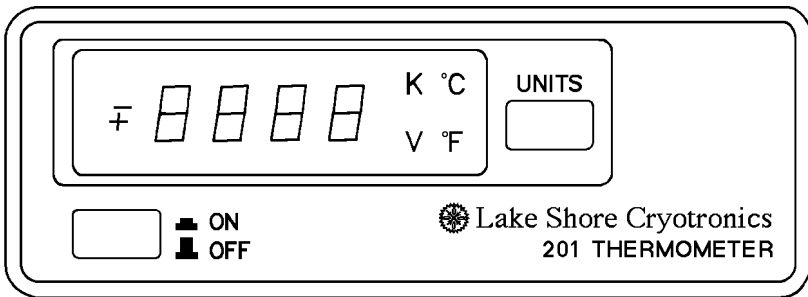

P-201-1-1.bmp

Figure 3-1. Model 201 Front Panel

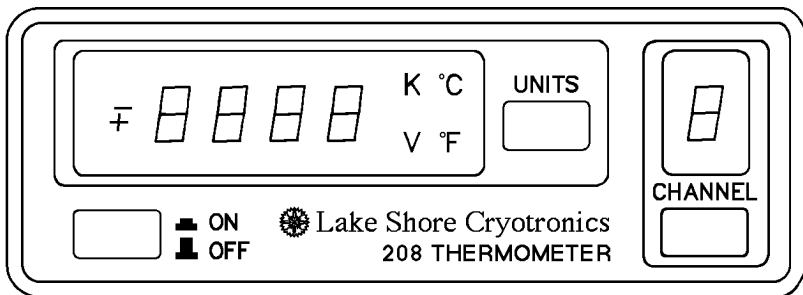

P-201-1-2.bmp

Figure 3-2. Model 208 Front Panel

### 3.5 ALARM OPERATION

Operation of the Model 201/208 alarm is detailed in the following paragraphs. Alarm setpoint is described in Paragraph 3.5.1, latched and unlatched alarms in Paragraph 3.5.2, and the alarm fix function (Model 208 only) in Paragraph 3.5.3.

#### 3.5.1 Alarm Setpoint

The alarm setpoint is a temperature which activates the alarm relay. The alarm setpoint can be set to warn of temperatures rising above a certain point (high alarm), or falling below a certain point (low alarm).

**NOTE:** Alarm setpoints work for temperatures, not voltage. If in voltage mode while setting an alarm setpoint, the thermometer will default to kelvin for the alarm setpoint.

To display the alarm setpoint, move the SET switch on the rear panel to position 1. The setpoint will be indicated in the display. In order to change the setpoint:

1. Make sure the SET switch is in position 1.
2. Hold the UNITS key until the desired temperature is reached. UNITS is a toggle. If the UNITS key is released and pressed again, the temperature direction is reversed. When the temperature display is increasing, the alarm will be a high setpoint. If temperature display is decreasing, the alarm will be a low setpoint.
3. Release the UNITS key when the desired setpoint is reached.

For a Model 208, press the CHANNEL key to set the alarm for each channel displayed in the channel window and repeat the steps above.

Move the SET switch back to position 0. The alarm is now enabled. When it is triggered an alarm status light will appear in the upper left of the temperature display.

The alarm can be connected to another device which will be triggered when the alarm is activated. The three contact terminal block is present on the rear panel as J3 ALARM. The alarm contacts are designated 1 COM 2 with 1 representing the normally open state and 2 representing the normally closed state.

### 3.5.2 Latched And Unlatched Alarms

Alarms can be either latched or unlatched. The alarm is latched when the LATCH switch is in position 1. The alarm will turn on when triggered by the alarm setpoint, but will *not* automatically turn off when the temperature drops below the high setpoint or rises above the low setpoint. The alarm is unlatched when the LATCH switch is in position 0. When unlatched, the alarm will turn on when temperatures go beyond the setpoint range, and automatically turn off when temperatures return to below the high setpoint or above the low setpoint.

### 3.5.3 Alarm Fix Function (Model 208 Only)

When the FIX switch on the rear panel of Model 208 is OFF (position 0), the relay will be continuously updated depending on the alarm setpoint and sensor temperature. If the FIX switch is on (position 1), the relay will be updated only when the channel 1 input is active.

## 3.6 SOFTCAL COMPENSATIONS

SoftCal is an instrument-configured software calibration procedure that is used to improve the system accuracy over a specified temperature range. The SoftCal feature allows the user to reduce the error between a DT-470 diode and the Standard Curve 10 employed by the instrument. In short, SoftCal provides the means to generate inexpensive calibrations for DT-470 sensors used with Lake Shore temperature controllers and monitors.

SoftCal calibrations are made at three points: liquid helium temperature (4.2 K), liquid nitrogen temperature (about 77 K) and room temperature (305 K). Resultant accuracy\* of the DT-470-SD-13 sensor will be:

±0.5 K	2 K to <30 K
±0.25 K	30 K to <60 K
±0.15 K	60 K to <345 K
±0.25 K	345 K to <375 K
±1.0 K	375 K to 475 K

\*These accuracy values can generally be achieved for all sensors in the silicon diode family. Two-point only SoftCal calibrations are appropriate for DT-470 series Band 11, 11A sensors and DT-471 diodes.

### 3.6.1 SoftCal Calibration

The following is the Model 201/208 SoftCal calibration procedure.

1. Turn on thermometer 30 minutes prior to operation.
2. Place the SET switch in position 1.
3. Hold the UNITS key until the display shows 0 kelvin (or equivalent in °C or °F). The key acts as a toggle. If the display is rising, release and press again.
4. Press the CAL ENABLE button on rear panel with a pen tip. The display will read - 5 0 F - to indicate that the unit is ready to erase current SoftCal calibration. Within 2 seconds press the UNITS key again. The temperature display will change from - 5 0 F - to the current SoftCal setting.
5. Hold the UNITS key until the sensor temperature is displayed. For example, if SoftCal is being set for liquid helium, the display should read 4.2 K. If it is being set for ice point, then the display should read 0 °C.
6. Be certain the sensor is stabilized at calibration temperature.
7. Press the CAL ENABLE button again. - 5 0 F - will again appear on display to indicate that the unit is ready to accept the calibration point. Within 2 seconds, press the UNITS key on the front panel if a new calibrations point is being entered. (If the UNITS key is not pressed within 2 seconds, the display will return to the alarm temperature.) After 15 seconds, the alarm setpoint temperature will display.
8. If more than one point is desired, go back to step 5. Note that one point may be entered between 1.4 K to 9.9 K. No point may be entered between 10 K and 40 K. Two points may be entered above 40 K.
9. Return the SET switch to position 0.

### 3.6.2 Verifying SoftCal Operation

The status of SoftCal can be checked by holding the UNITS key for 2 to 3 seconds. If SoftCal is not in operation, - 0 0 0 - will display.

If the first digit of the display is 1, SoftCal is set for below 28 K.  
If either the second or third digit is 1, SoftCal is set for above 28 K.

### 3.6.3 Erasing SoftCal Compensations

When SoftCal compensations are erased, the thermometer returns to normal operation.

1. Move the SET switch to position 1.
2. Use the UNITS key to change the front panel display to 0.  
This key is a toggle. If the display moves in the wrong direction, release and press again.
3. Press the CAL ENABLE button on rear panel using a pen tip.  
The display will change from 0 to - 5 0 F-. The alarm setpoint will display after the SoftCal compensation has been erased.
4. Move the SET switch to position 0.



## CHAPTER 4

# REMOTE OPERATION

### 4.0 GENERAL

The Model 201/208 Digital Thermometer has a built-in Serial Interface that can be used for operational and service purposes. Details of the Serial Interface are provided in Paragraph 4.1. Serial Interface Commands are described in Paragraph 4.2.

### 4.1 SERIAL INTERFACE

The Model 201/208 has a serial interface for RS-232C communications with a host computer. RS-232C is an unbalanced (single ended), non-terminated line used over short distances (typically 10 feet or less). The Model 201/208 serial interface complies with the electrical format of the RS-232C Interface Standard. A standard 6-wire RJ-11 modular (telephone) jack is used for the serial interface connector.

Serial interface specifications are given in Table 4-1. Serial interface connections are defined in Paragraph 4.1.1. The serial interface hardware configuration and adapters are shown in Figures 4-1 and 4-2. The serial interface operation is outlined in Paragraph 4.1.2. Sample Basica and QuickBasic Programs are provided in Paragraphs 4.1.3 and 4.1.4 respectively.

**Table 4-1. Serial Interface Specifications**

Transmission:	Three-Wire
Connector:	RJ-11 Modular (Telephone) Socket
Timing Format:	Asynchronous
Transmission Mode:	Half Duplex
Baud Rate:	300
Bits per Character:	1 Start, 7 Data, 1 Parity, 1 Stop
Parity Type:	Odd
Data Interface Levels:	Transmits/Receives Using EIA Levels
Terminator:	LF (0AH)

#### 4.1.1 Serial Interface Connections

A standard 6-wire RJ-11 modular (telephone) jack is used for the serial interface connector. Lake Shore Model 2001 data type cables—which maintains pin 1 polarity—are used to simplify interconnection. Lake Shore offers the Model 2002 RJ-11 to DB-25 adapter and Model 2003 RJ-11 to DB-9 adapter for connecting to the host computer. See Figure 4-2.

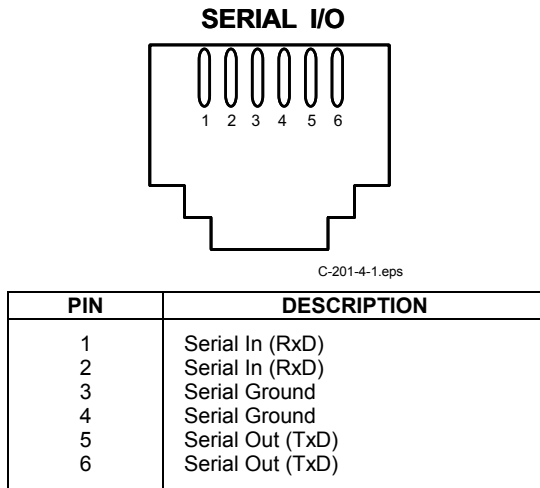

**Figure 4-1. Serial I/O (RJ-11) Connector Pin Definitions**

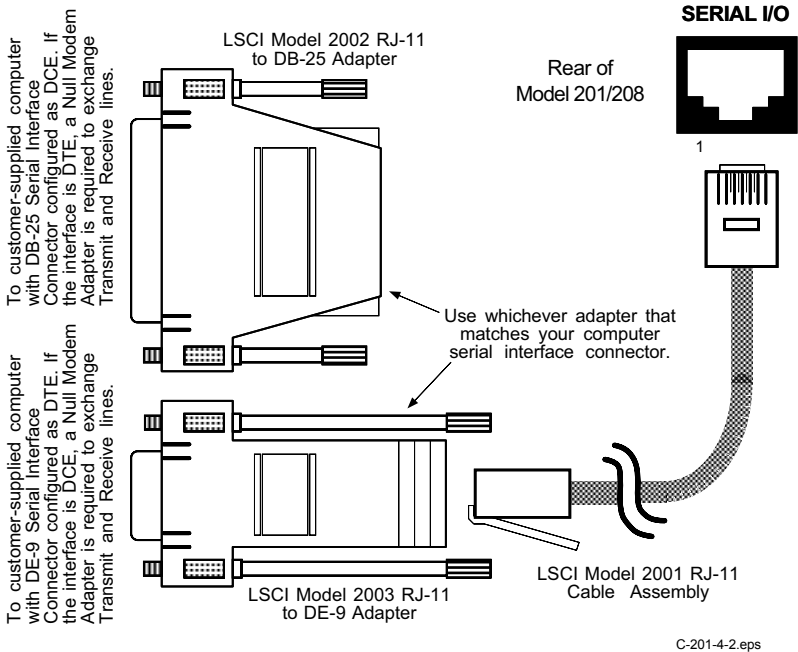

**Figure 4-2. Serial Interface Connections**

#### 4.1.2 Serial Interface Operation

All thermometer functions, except setting SoftCal compensations, can be controlled remotely from a host computer equipped with communications software and modem. Located on the rear panel is a RJ-11 modular socket designated J2 SERIAL I/O for host computer connection. Accessories 2001 (RS-232C phone cord) and 2002 (RJ-11 to DB-25 adapter), as well as a null modem adapter may be required to link the serial port on the host computer directly to the thermometer. When programming a Model 201/208 from the serial interface, the following considerations must be made.

- Commands must be typed in all CAPS.
- When the term free field is used, it indicates that the decimal point is a floating entity and can be placed any appropriate place in the string of digits.
- [term] is used when examples are given and indicates where terminating characters should be placed by the user or where they appear on a returning character string from the unit.
- Leading zeros and zeros following a decimal point are not needed in a command string, but they will be sent in response to a query.
- Temperature is to be entered to 0.1 degrees. If entered with greater precision, it will be truncated. Also, temperature is limited to 0 to 475 K.
- There should be no space between the commands and the variable being sent.

### 4.1.3 Sample Basica Program

```

10 OPEN "COM1:300,O,7,1,RS" AS #1  'OPEN UP THE COM PORT
11 PRINT "TYPE 'QUIT' TO EXIT"    'PRINT QUIT MESSAGE
12 PRINT                          'PRINT BLANK LINE
20 INPUT "ENTER COMMAND";A$      'GET COMMAND TO SEND
21 IF A$ = "QUIT" THEN GOTO 100  'LOOK FOR QUIT THEN QUIT
30 A$ = A$ +CHR$(13)+CHR$(10)    'ADDING CR AND LF
40 PRINT #1,A$;                  'SENDING COMMAND STRING
45 R = INSTR(A$,"W")             'SCAN CMD FOR W/QUERY
46 IF R = 0 THEN GOTO 90         'IF NOT A QUERY SKIP PRINT
50 FOR Z = 1 TO 500: NEXT Z     'SHORT DELAY
60 LINE INPUT #1,B$             'READ BACK 201/208 RESPONSE
70 PRINT B$;                    'PRINT INSTRUMENT RESPONSE
90 GOTO 11                       'JUMP BACK TO THE BEGINNING
100 CLOSE #1                    'CLOSE COM PORT
101 END                          'END PROGRAM

```

### 4.1.4 Sample Quick Basic 4.0 Program

```

STARTUP: OPEN "COM1:300,O,7,1,RS" FOR RANDOM AS #1
                                                'open the serial port
        PRINT "TYPE 'QUIT' TO EXIT"        'print 'QUIT' message
RESTART: PRINT                              'print blank line
        INPUT "ENTER COMMAND"; A$         'get command to send
        IF A$ = "QUIT" THEN GOTO FINISH  'check quit request
        A$ = A$ + CHR$(13) + CHR$(10)    'adding CR and LF
        PRINT #1, A$;                    'sending command string
        R = INSTR(A$, "W")                'scan for W/query
        IF R = 0 THEN GOTO REJUMP        'if not query skip print
        FOR Z = 1 TO 500: NEXT Z         'short delay
        LINE INPUT #1, B$                'read back unit response
        PRINT B$;                        'print instrument response
REJUMP:  GOTO RESTART                    'jump back to beginning
FINISH:  CLOSE #1                        'close serial port
        END                              'end/exit program

```

## 4.2 SERIAL INTERFACE COMMANDS

The following is a summary of the Serial Interface Commands recognized by the Model 201/208 Digital Thermometer.

<b>Command</b>	<b>Function</b>
<b>F0</b> .....	Sensor Units for Setpoint
<b>H</b> .....	High Alarm Setpoint
<b>L</b> .....	Low Alarm Setpoint
<b>R</b> .....	Reset Alarm
<b>Y</b> .....	Scan Dwell Time *
<b>YC</b> .....	Scanner Channel Selection *
<b>YS</b> .....	Scan Enable *
<b>YH</b> .....	Scan Disable *
<b>WS</b> .....	Sensor Reading and Alarm Status Query
<b>WA</b> .....	Switch ID and Alarm Data Query
<b>WY</b> .....	Scan and Dwell Query *

\* Model 208 Only

An explanation of the command structure is shown below.

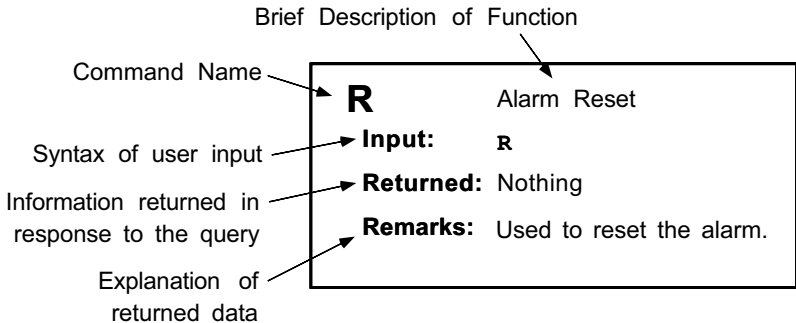

**Serial Interface Commands (Continued)**

---

**F0** Set Temperature Display Sensor Units  
**Input:** F0x  
**Returned:** Nothing  
**Remarks:** Used to set the sensor units for the temperature display, where “x” equals C for Celsius, F for Fahrenheit, K for kelvin, or V for volts.

---

**H** Select High Alarm Setpoint Value  
**Input:** Hxxx . x  
**Returned:** Nothing  
**Remarks:** Used to select the high alarm setpoint value where “xxx.x” equals the temperature setpoint. Units will be as specified by command F0. If the instrument is set for voltage units, the alarm will default to kelvin units.  
**Example:** H300[term] sets a high alarm setpoint of 300 degrees.

---

**L** Select Low Alarm Setpoint Value  
**Input:** Lxxx . x  
**Returned:** Nothing  
**Remarks:** Used to select the low alarm setpoint value where “xxx.x” equals the temperature setpoint. Units will be as specified by command F0. If the instrument is set for voltage units, the alarm will default to kelvin units.  
**Example:** L31.2[term] sets a low alarm setpoint of 31.2 degrees.

---

**R** Alarm Reset  
**Input:** R  
**Returned:** Nothing  
**Remarks:** Used to reset the alarm.

---

**Serial Interface Commands** (Continued)

---

**Y** Channel Dwell Time (Model 208 Only)

**Input:** **Yab**

**Returned:** Nothing

**Remarks:** On a Model 208 only, this command is used to set the dwell time for a given channel, where "a" equals the channel 1 - 8 and "b" equals the dwell time parameter as follows:

0	0 seconds
1	5 seconds
2	10 seconds
3	30 seconds
4	60 seconds

Setting the dwell time to 0 causes the channel be skipped in the sequence.

**Example:** Y23[term] selects channel 2 and sets the dwell time for 30 seconds.

---

**YC** Channel Scanner Channel (Model 208 Only)

**Input:** **YCx**

**Returned:** Nothing

**Remarks:** For a Model 208 only, this command asynchronously selects a scanner channel for readout independent of the "scan" feature, where "x" equals channel 1–8.

---

**YS** Begin Scanning (Model 208 Only)

**Input:** **ys**

**Returned:** Nothing

**Remarks:** For a Model 208 only, starts the scan of the inputs from the input channel which it is currently on. The instrument skips every channel with a dwell time of zero.

---

**Serial Interface Commands** (Continued)

---

**YH** End Scanning (Model 208 Only)  
**Input:** YH  
**Returned:** Nothing  
**Remarks:** For a Model 208 only, stops the scan of the inputs from the input channel which it is currently on. The scanner should be on hold when any of the other scanner commands are sent to the scanner or unpredictable results could occur.

---

**WS** Sample Sensor Reading and Alarm Status  
**Input:** ws  
**Returned:** The following is returned for a Model 201:  
[sign],[sensor reading],[units],[alarm status](CR)(LF)  
The following is returned for a Model 208:  
[current channel],[sign],[sensor reading],[units],  
[alarm status](CR)(LF)  
**Remarks:** Gives the sample sensor reading and the alarm status. For the alarm status parameter, A indicates active while I indicates inactive.

---



**Serial Interface Commands** (Continued)

---

**WA** Switch ID and Alarm Data

**Input:** **WA**

**Returned:** The following is returned for a Model 201:  
[switch ID],[high or low alarm],[alarm sign],  
[alarm setpoint](CR)(LF)

The following is returned for a Model 208:  
[switch ID],[high or low alarm],[alarm sign],  
[alarm setpoint],[active channel number](CR)(LF)

**Remarks:** Provides the switch ID and alarm data. The switch ID parameter is 0 through 3 for the Model 201. Its the sum of 1 if the alarm set enable is set, plus 2 if relay latching is desired. The switch ID parameter is 0 through 7 for the Model 208. Its the sum of 1 if the alarm set enable is set, plus 2 if relay latching is desired, plus 4 if the alarm fix is enabled. The high or low parameter is H for a high alarm or L for a low alarm.

---

**WY** Scan Status (Model 208 Only)

**Input:** **WY**

**Returned:** The following is returned for a Model 208:  
[scan status],[current channel number],[channel which  
caused the alarm state], [channel 1 dwell time],[channel 2  
dwell time],...[channel 8 dwell time](CR)(LF)

**Remarks:** For a Model 208 only, returns the instrument scan status (scanning or holding), the channel dwell information, and the scan position. The scan status parameter is H for holding of S for scanning. The channel which caused the alarm state parameter will be 1 through 8 or a "-" if the alarm is not active. The channel dwell times will be returned in seconds. If this command is sent with a Model 201, an "N" will be returned to signify no scanner.

---

This Page Intentionally Left Blank

# CHAPTER 5

## SERVICE

### 5.0 GENERAL

This chapter contains service information for the Model 201/208 Digital Thermometer. Model 201 rear panel connections are defined in Paragraph 5.1, Model 208 rear panel connections in Paragraph 5.2, error code troubleshooting in Paragraph 5.3, general maintenance in Paragraph 5.4, fuse replacement in Paragraph 5.5, line voltage selection in Paragraph 5.6, calibration in Paragraph 5.7, and serial interface cable and adapters in Paragraph 5.8.

### 5.1 MODEL 201 REAR PANEL CONNECTIONS

Model 201 rear panel connections and controls are defined below. See Figure 5-1.

**J1 INPUT 1:** Accepts a circular 4-pin connector temperature sensor (201-MC).

**J2 SERIAL I/O:** RJ-11 jack for serial remote communications to a host computer. May require accessories 2001 (RJ-11 phone cord) and 2002 (RJ-11 to DB-25 adapter).

**J3 ALARM:** Relay responds to alarm setpoints and can trigger another device. Contact 1 is normally open, contact 2 is normally closed.

★ switch: Not used.

**LATCH switch:** When on (position 1), turns alarm on but not off (latched) as indicated by temperature change. When off (position 0), turns alarm off or on (unlatched).

**SET switch:** Used in setting alarm setpoints and recalibration.

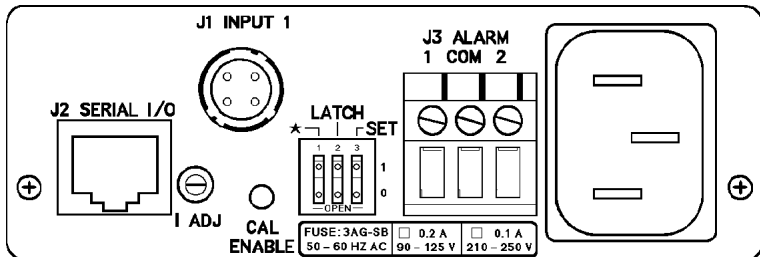

P-201-5-1.bmp

Figure 5-1. Model 201 Rear Panel Connections

**Model 201 Rear Panel Connections (Continued)**

**CAL ENABLE** (Calibration Enable) pushbutton: Used during A/D Converter Calibration. Refer to Paragraph 5.7.2.

**I ADJ** (Current Adjust) trim potentiometer: Used during Current Source Calibration. Refer to Paragraph 5.7.1.

**5.2 MODEL 208 REAR PANEL CONNECTIONS**

Model 208 rear panel connections and controls are defined below. See Figure 5-2.

**J1 INPUTS:** Accepts 36-pin “D” style connector (208-MC) and multi-sensor adapters. Adapter sits on top of thermometer and accepts up to 8 temperature sensors. Adapter designed for either circular 4-pin (2084) or stripped wire (2081) sensors.

**J2 SERIAL I/O:** RJ-11 jack for serial remote communications to a host computer. May require accessories 2001 (RS-232C phone cord) and 2002 (RJ-11 to DB-25 adapter).

**J3 ALARM:** Relay responds to alarm setpoints, and can trigger another device. Contact 1 is normally open, contact 2 is normally closed.

**FIX** switch: Switches alarm functions between monitoring all channels (position 0) or monitoring channel 1 only (position 1).

**LATCH** switch: When on (position 1), turns alarm on but not off (latched) as indicated by temperature change. When off (position 0), turns alarm off or on (unlatched).

**SET** switch: Used in setting alarm setpoints and recalibration.

**CAL ENABLE** (Calibration Enable) pushbutton: Used during A/D Converter Calibration. Refer to Paragraph 5.7.2.

**I ADJ** (Current Adjust) trim potentiometer: Used during Current Source Calibration. Refer to Paragraph 5.7.1.

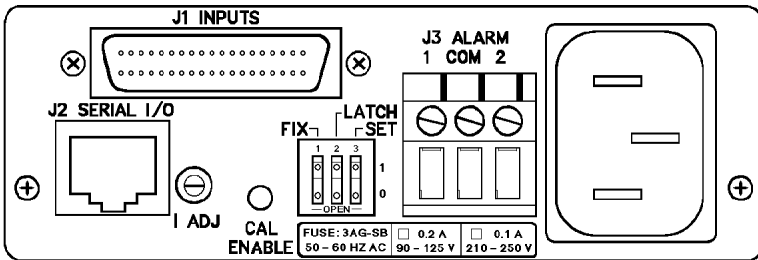

P-201-5-2.bmp

**Figure 5-2. Model 208 Rear Panel Connections**

### 5.3 ERROR CODE TROUBLESHOOTING

On power up, the 201/208 does a check of the internal memory. In the event that a problem exists, an error message will be displayed on the instrument's front panel.

“**Er01**” on the display, indicates that there is a hardware problem in the instrument's memory. In the case of Er01 or other failures, use the following procedure.

**CAUTION:** This procedure erases the calibration constants stored in the non-volatile RAM. If this procedure is used, it will be necessary to recalibrate the instrument.

1. With the power turned off, press and hold the recessed CAL ENABLE button on the back panel. While holding the CAL ENABLE button, turn power to the instrument on.
2. If the Model 201/208 now displays Er02, then proceed to the Calibration procedure in Paragraph 5.7. If the Er01 is still displayed or if the Model 201/208 does not respond, please contact the Instrument Service Department at Lake Shore Cryotronics at (614) 891-2243, or the Dealer/Representative from which the Model 201/208 was purchased.

“**Er02**” on the display indicates that there is a soft error in the instrument's memory. In the case of Er02, use the following procedure.

1. Power up the unit and allow it to display Er02.
2. Close DIP Switch 1 (top of the switch pressed in). Leave the switch closed for at least 5 seconds, then open DIP switch 1 (bottom of the switch pressed in).
3. Verify the Model 201/208 display goes through a normal power up sequence and then displays 499.9 K.
4. The input(s) of the Model 201/208 must now be recalibrated per in procedure in Paragraph 5.7 before the unit can be used.

“**OL**” means overload, indicating the voltage input is too high. This can be caused by an open sensor or diode sensor wired backwards.

## 5.4 GENERAL MAINTENANCE

Clean the 201/208 periodically to remove dust, grease and other contaminants. Use the following procedure:

**NOTE:** Do not use aromatic hydrocarbons or chlorinated solvents to clean the Model 201/208. They may react with the silk screen printing on the back panel.

1. Clean the front and back panels and case with a soft cloth dampened with a mild detergent and water solution.

## 5.5 FUSE REPLACEMENT

Use the following procedure to check and/or replace the fuse:

**WARNING:** To prevent shock hazard, turn off the instrument and disconnect it from AC line power and all test equipment before replacing the fuse.

1. Turn POWER switch off and disconnect the power cord from the unit. Also, disconnect all test equipment from unit.
2. Remove all screws from rear panel. Gently pull away rear panel and remove enclosure cover by sliding it to the back.
3. Remove fuse with a fuse puller. The fuse is located behind the transformer as shown in Figure 5-3.
4. Replace with a 0.2 ampere fuse for 110 V (115 VAC) operation or a 0.1 ampere fuse for 220 V (230 VAC) operation. Both values are to be slow blow fuses.

**CAUTION:** Replace fuse with the same type and rating as specified by the line voltage selected.

5. Replace enclosure cover, rear panel and all screws.

## 5.6 Line Voltage Configuration

The rear-panel, three-pronged line power connector permits the Model 201/208 to be connected to operate at either 110 or 220 VAC. The configuration is indicated on rear panel in the Line Voltage Selection Block. Use the following procedure to change the line voltage.

**WARNING:** To prevent shock hazard, turn off the instrument and disconnect it from AC line power. Also ensure any attached test equipment is disconnected before changing the line voltage configuration.

**Line Voltage Configuration** (Continued)

1. Place the power ON/OFF switch to OFF and disconnect the power cord from the unit. Also, disconnect all test equipment from unit.
2. Remove all screws from rear panel. Gently pull away rear panel and remove enclosure cover by sliding it to the back.
3. Modify jumper configuration to desired line voltage as shown in Figure 5-3.
4. Replace fuse to match new voltage requirements.
5. Replace enclosure cover, rear panel and all screws.

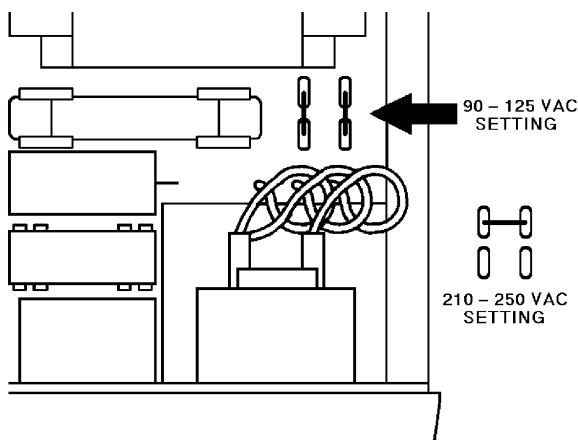

P-201-5-3.bmp

**Figure 5-3. Line Voltage Jumper Configuration**

**5.7 Recalibration**

Lake Shore will calibrate and certify the thermometer to original factory specifications for a reasonable fee. You can recalibrate the thermometer to original specifications, but Lake Shore will not warrant these calibrations.

Recalibration requires a digital voltmeter (DVM) with 4½-digit resolution or better; and 25 K $\Omega$  and 125 K $\Omega$  precision resistors with  $\pm 0.01\%$  tolerance or better.

Recalibration involves current source and analog/digital (A/D) converter calibration. A/D calibration will erase all SoftCal compensations and must be done after current source calibration and not before.

### 5.7.1 Current Source Calibration

1. Allow 30 minute warm-up to achieve rated specifications.
2. Configure 125 k $\Omega$  resistor as shown in Figure 5-4. Model 208s should be on channel 1.
3. Connect the voltage leads of the DVM across the resistor and adjust the I ADJ trimpot (located on rear panel) until DVM displays a voltage of 1.2500 volts  $\pm$ 100 microvolts.
4. Remove DVM and resistor.

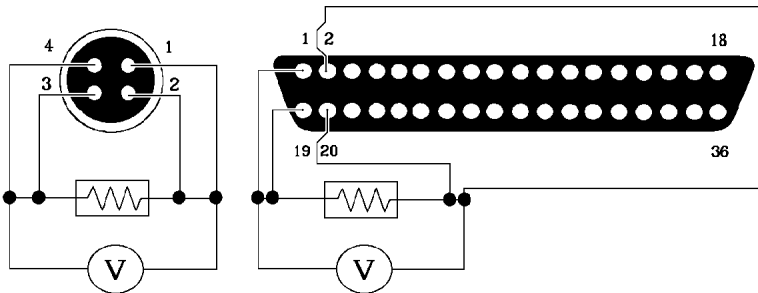

NOTE: Do not use a voltmeter for A/D converter calibration.

D-201-U-5-4

**Figure 5-4. Calibration Connections**

### 5.7.2 A/D Converter Calibration

**NOTE:** Current source calibration *must* be performed *before* A/D converter calibration.

1. Allow 30 minute warm-up to achieve rated specifications.
2. Perform current source calibration.
3. Configure 125 k $\Omega$  resistor as shown in Figure 5-4. Model 208s should be on channel 1.
4. Wait 10 seconds for resistor voltage to settle.
5. Press CAL ENABLE button, then within 2 seconds press UNITS key. The display window will show - C R L - for approximately 15 seconds.
6. Repeat procedure with 25 k $\Omega$  resistor.
7. For Model 208, repeat procedure for other 7 channels. See Figure 2-2 for pin assignments.



### 5.8 SERIAL INTERFACE CABLE AND ADAPTERS

To aid in Serial Interface troubleshooting, wiring information for the cable assembly and the two mating adapters are provided in Figures 5-5 thru 5-7.

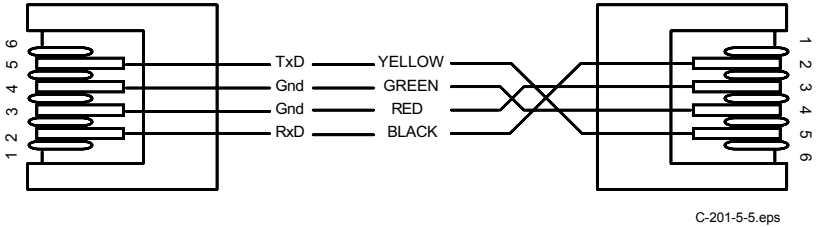

**Figure 5-5. Model 2001 RJ-11 Cable Assembly Wiring Details**

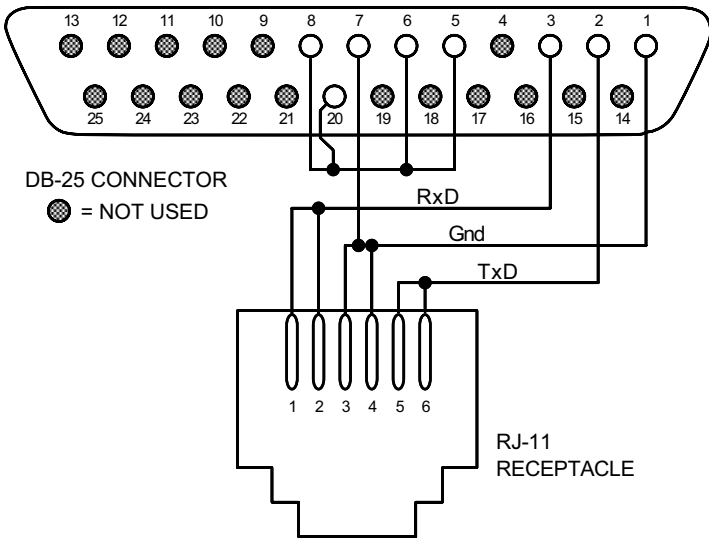

**Figure 5-6. Model 2002 RJ-11 to DB-25 Adapter Wiring Details**

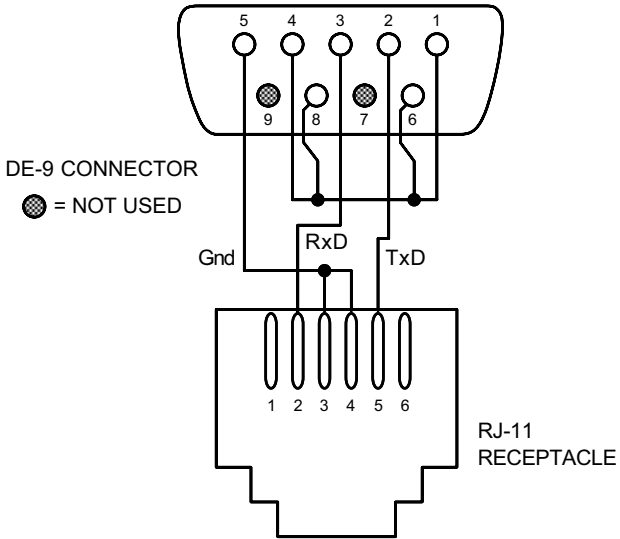

C-201-5-7.eps

**Figure 5-7. Model 2003 RJ-11 to DE-9 Adapter Wiring Details**

## CHAPTER 6

### OPTIONS AND ACCESSORIES

#### 6.0 GENERAL

This chapter provides lists of models, options, accessories, sensors, wires, and special equipment available for the Model 201/208.

#### 6.1 MODELS

A list of the available Digital Thermometer models are as follows:

Model	Description of Model
<b>201-115</b>	Single-Channel Digital Thermometer configured for 90–140 VAC. Includes one Model 201-MC Connector.
<b>201-230</b>	Single-Channel Digital Thermometer configured for 200–250 VAC. Includes one Model 201-MC Connector.
<b>208-115</b>	Eight-Channel Digital Thermometer configured for 90–140 VAC. Includes one Model 208-MC Connector.
<b>208-230</b>	Eight-Channel Digital Thermometer configured for 200–250 VAC. Includes one Model 208-MC Connector.

#### 6.2 ACCESSORIES

A list of accessories available for the Model 201/208 are as follows:

Model	Description of Accessory
<b>2001</b>	RJ-11 to RJ-11 Cable Assembly, 10 feet (3 meters). See Figure 6-1.
<b>2002</b>	RJ-11 to DB-25 Adapter. Connects RJ-11 to Serial Port on rear of computer. See Figure 6-2.
<b>2003</b>	RJ-11 to DE-9 Adapter. Connects RJ-11 to Serial Port on rear of computer. See Figure 6-3.
<b>2010</b>	Calibration connector set for Model 201 only.
<b>2080</b>	Calibration connector set for Model 208 only.
<b>2081</b>	Screw Terminal Adapter. Used with Model 208 for convenient connection to multiple sensor/probe assemblies (with stripped ends) that will not be permanently wired. Provision for attachment to top of thermometer. Fitted with "D" type mating connector.

**Accessories (Continued)**

<b>Model</b>	<b>Description of Accessory</b>
<b>2082-1</b>	Sensor Probe. 4 inches (10 cm) long by 1/8-inch (3.2 mm) diameter stainless steel probe with 6 foot (1.83 meter) cable with 4 stripped ends.
<b>2082-2</b>	Sensor Probe. 4 inches (10 cm) long by 1/8-inch (3.2 mm) diameter stainless steel probe with 6 foot (1.83 meter) cable with 4-pin 201-MC mating connector.
<b>2082-3</b>	Sensor Probe. 6 inches (15 cm) long by 1/8-inch (3.2 mm) diameter stainless steel probe with 12 foot (3.7 meter) cable with 4 stripped ends.
<b>2082-4</b>	Sensor Probe. 6 inches (15 cm) long by 1/8-inch (3.2 mm) diameter stainless steel probe with 12 foot (3.7 meter) cable with 4-pin 201-MC mating connector.
<b>2083-1</b>	Sensor Probe. 12 foot (3.7 meter) cable with DT-470-SD-13 sensor in CY mounting adapter, stripped ends. Temperature range limited to 325 K (52 °C). The diode sensor is epoxied (Stycast) into center of 0.564 inch (1.43 cm) diameter by 0.20 inch (5 mm) thick copper disk. 30 AWG copper leads anchored to disk. Mass (excluding leads) is 4.3 grams.
<b>2083-2</b>	Sensor Probe. 12 foot (3.7 meter) cable with DT-470-SD-13 sensor in CY mounting adapter, with 4-pin 201-MC mating connector. Temperature range limited to 325 K (52 °C). The diode sensor is epoxied (Stycast) into center of 0.564 inch (1.43 cm) diameter by 0.20 inch (5 mm) thick copper disk. 30 AWG copper leads anchored to disk. Mass (excluding leads) is 4.3 grams.
<b>2084</b>	Multi-Connector Adapter. Required with Model 208 when multiple probe/cable assemblies and multiple Model 201-MC mating connectors are used.
<b>2090</b>	Mounting Adapter for Rack Installation. For installation in a ¼ panel EIA rack space. See Figure 2-3.
<b>201-MC</b>	4-pin Mating Connector for Model 201 and Model 2084.
<b>208-MC</b>	36-pin "D" Style Connector for Model 208.

### 6.3 WIRES

A list of wire available for the Model 201/208 are as follows:

P/N	Cable Description
9001-005	<b>Quad-Twist™ Cryogenic Wire.</b> Two twisted pairs, phosphor-bronze wire, 36 AWG, 0.127 mm (0.005 inch) diameter.
9001-006	<b>Duo-Twist™ Cryogenic Wire.</b> Single twisted pair, phosphor-bronze wire, 36 AWG, 0.127 mm (0.005 inch) diameter.
9001-007	<b>Quad-Lead™ Cryogenic Wire.</b> Phosphor-bronze wire, flat, 32 AWG, 0.203 mm (0.008 inch) diameter.
9001-008	<b>Quad-Lead™ Cryogenic Wire.</b> Phosphor-bronze wire, flat, 32 AWG, 0.127 mm (0.005 inch) diameter.
—	Any quality dual shield twisted pair wire for dewar to Model 201/208 connector.

### 6.4 SENSORS

A list of sensors available for the Model 201/208 are as follows:

Sensor No.	Sensor Description
<b>Series DT-420</b>	The smallest silicon diode Temperature Sensor available. For installation on flat surfaces. Sensor incorporates the same type of silicon chip used in the Series DT-470 and DT-471.
<b>Series DT-450</b>	Silicon Diode Miniature Temperature Sensor. Same silicon chip used in the DT-470 configured for installation in recesses as small as 1.6 mm diameter by 3.2 mm deep.
<b>Series DT-470</b>	Silicon Diode Temperature Sensor. Interchangeable, repeatable, accurate, wide range customized for cryogenics.
<b>Series DT-471</b>	An economical version of the DT-470 for applications where temperature measurements below 10 K are not required.

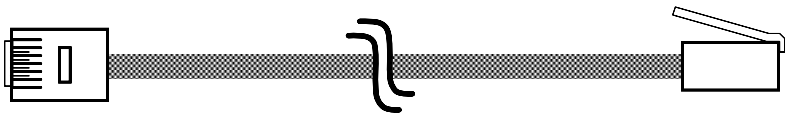

Cable Length: 4.3 meters (14 feet)

C-201-6-1.eps

**Figure 6-1. Model 2001 RJ-11 Cable Assembly**

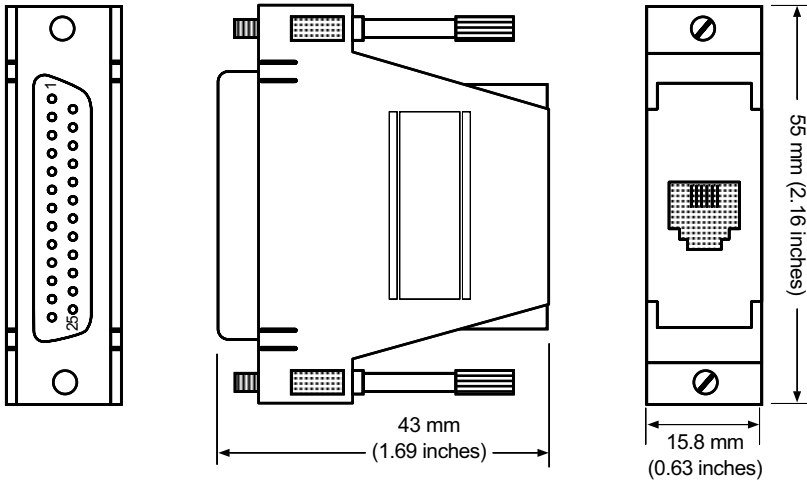

C-201-6-2.eps

**Figure 6-2. Model 2002 RJ-11 to DB-25 Adapter**

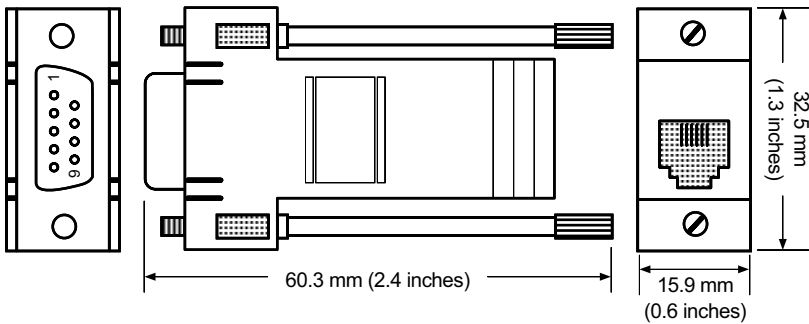

C-201-6-3.eps

**Figure 6-3. Model 2003 RJ-11 to DE-9 Adapter**

# APPENDIX A

## GLOSSARY OF TERMINOLOGY

**absolute zero.** The temperature of  $-273.15\text{ }^{\circ}\text{C}$ , or  $-459.67\text{ }^{\circ}\text{F}$ , or  $0\text{ K}$ , thought to be the temperature at which molecular motion vanishes and a body would have no heat energy.<sup>1</sup>

**active length.** Defined as the electrically active length of the helium level sensor. As opposed to actual physical length, which, due to sensor mounting provisions, will be somewhat larger.

**alarm setpoints.** Low and high alarm setpoints are defined by the user. The low alarm is always active and will sound whenever the LHe level drops below the setpoint. The high alarm is only active in Continuous Mode (used during filling) and will sound when the LHe level rises above the setpoint.

**ambient temperature.** The temperature of the surrounding medium, such as gas or liquid, which comes into contact with the apparatus.<sup>1</sup>

**American Standard Code for Information Exchange (ACSII).** A standard code used in data transmission, in which 128 numerals, letters, symbols, and special control codes are represented by a 7-bit binary number as follows:

Bits				Col	0 <sub>0</sub>	0 <sub>0</sub> 1	0 <sub>1</sub> 0	0 <sub>1</sub> 1	1 <sub>0</sub> 0	1 <sub>0</sub> 1	1 <sub>1</sub> 0	1 <sub>1</sub> 1
b <sub>7</sub>	b <sub>6</sub>	b <sub>5</sub>	b <sub>4</sub>	Row	0	1	2	3	4	5	6	7
1	1	1	1	0	NUL	DLE	SP	0	'	P	@	p
0	0	0	1	1	SOH	DC1	!	1	A	Q	a	q
0	0	1	0	2	STX	DC2	"	2	B	R	b	r
0	0	1	1	3	ETX	DC3	#	3	C	S	c	s
0	1	0	0	4	EOT	DC4	\$	4	D	T	d	t
0	1	0	1	5	ENG	NAK	%	5	E	U	e	u
0	1	1	0	6	ACK	SYN	&	6	F	V	f	v
0	1	1	1	7	BEL	ETB	'	7	G	W	g	w
1	0	0	0	8	BS	CAN	(	8	H	X	h	x
1	0	0	1	9	HT	EM	)	9	I	Y	i	y
1	0	1	0	10	LF	SS	*	:	J	Z	j	z
1	0	1	1	11	VT	ESC	+	;	K	[	k	{
1	1	0	0	12	FF	FS	,	<	L	~	l	~
1	1	0	1	13	CR	GS	-	=	M	]	m	}
1	1	1	0	14	SO	RS	.	>	N	^	n	
1	1	1	1	15	SI	US	/	?	0	_	o	DEL

**asphyxiant gas.** A gas which has little or no positive toxic effect but which can bring about unconsciousness and death by displacing air and thus depriving an organism of oxygen.

**baud.** A unit of signaling speed equal to the number of discrete conditions or signal events per second, or the reciprocal of the time of the shortest signal element in a character.<sup>2</sup>

**boiling point.** The temperature at which a substance in the liquid phase transforms to the gaseous phase; commonly refers to the boiling point at sea level and standard atmospheric pressure.

**Celsius ( $^{\circ}\text{C}$ ) Scale.** A temperature scale that registers the freezing point of water as  $0\text{ }^{\circ}\text{C}$  and the boiling point as  $100\text{ }^{\circ}\text{C}$  under normal atmospheric pressure. Celsius degrees are purely derived units, calculated from the Kelvin Thermodynamic Scale. Formerly known as "centigrade." See Temperature for conversions.

**cgs system of units.** A system in which the basic units are the centimeter, gram, and second.<sup>2</sup>

**cryogen.** See cryogenic fluid.<sup>1</sup>

**cryogenic.** Refers to the field of low temperatures, usually  $-130$  °F or below, as defined by 173.300(f) of Title 49 of the Code of Federal Regulations.

**cryogenic fluid.** A liquid that boils at temperatures of less than about 110 K at atmospheric pressure, such as hydrogen, helium, nitrogen, oxygen, air, or methane. Also known as cryogen.<sup>1</sup>

**cryostat.** An apparatus used to provide low-temperature environments in which operations may be carried out under controlled conditions.<sup>1</sup>

**degree.** An incremental value in the temperature scale, i.e., there are 100 degrees between the ice point and the boiling point of water in the Celsius scale and 180 degrees between the same two points in the Fahrenheit scale.

**electrostatic discharge (ESD).** A transfer of electrostatic charge between bodies at different electrostatic potentials caused by direct contact or induced by an electrostatic field.

**excitation.** Either an AC or DC input to a sensor used to produce an output signal. Common excitations include: constant current, constant voltage, or constant power.

**Fahrenheit (°F) Scale.** A temperature scale that registers the freezing point of water as 32 °F and the boiling point as 212 °F under normal atmospheric pressure. See Temperature for conversions.

**international system of units (SI).** A universal coherent system of units in which the following seven units are considered basic: meter, kilogram, second, ampere, kelvin, mole, and candela. The International System of Units, or *Système International d'Unités* (SI), was promulgated in 1960 by the Eleventh General Conference on Weights and Measures. For definition, spelling, and protocols, see Reference 3 for a short, convenient guide.

**IPTS-68.** International Practical Temperature Scale of 1968. Also abbreviated as  $T_{68}$ .

**ITS-90.** International Temperature Scale of 1990. Also abbreviated as  $T_{90}$ . This scale was designed to bring into as close a coincidence with thermodynamic temperatures as the best estimates in 1989 allowed.

**Kelvin (K).** The unit of temperature on the Kelvin Scale. It is one of the base units of SI. The word "degree" and its symbol (°) are omitted from this unit. See Temperature Scale for conversions.

**Kelvin Scale.** The Kelvin Thermodynamic Temperature Scale is the basis for all international scales, including the ITS-90. It is fixed at two points: the absolute zero of temperature (0 K), and the triple point of water (273.16 K), the equilibrium temperature that pure water reaches in the presence of ice and its own vapor.

**liquid helium (LHe).** Used for low temperature and superconductivity research: minimum purity 99.998%. Boiling point at 1 atm = 4.2 K. Latent heat of vaporization = 2.6 kilojoules per liter. Liquid density = 0.125 kilograms per liter.

EPA Hazard Categories: Immediate (Acute) Health and Sudden Release of Pressure Hazards

DOT Label: Nonflammable Gas

DOT Class: Nonflammable Gas

DOT Name: Helium, Refrigerated Liquid

DOT ID No: UN 1963



**liquid nitrogen (LN<sub>2</sub>).** Also used for low temperature and superconductivity research and for its refrigeration properties such as in freezing tissue cultures: minimum purity 99.998%, O<sub>2</sub> 8 ppm max. Boiling point at 1 atm = 77.4 K. Latent heat of vaporization = 160 kilojoules per liter. Liquid density = 0.81 kilograms per liter.

EPA Hazard Categories: Immediate (Acute) Health and Sudden Release of Pressure Hazards

DOT Label: Nonflammable Gas

DOT Class: Nonflammable Gas

DOT Name: Nitrogen, Refrigerated Liquid

DOT ID No: UN 1977

**LSCI.** Lake Shore Cryotronics, Inc.

**material safety data sheet (MSDS).** OSHA Form 20 contains descriptive information on hazardous chemicals under OSHA's Hazard Communication Standard (HCS).

These data sheets also provide precautionary information on the safe handling of the gas as well as emergency and first aid procedures.

**MKSA System of Units.** A system in which the basic units are the meter, kilogram, and second, and the ampere is a derived unit defined by assigning the magnitude  $4\pi \times 10^{-7}$  to the rationalized magnetic constant (sometimes called the permeability of space).

**NBS.** National Bureau of Standards. Now referred to as NIST.

**NbTi.** Niobium-titanium. A superconductive alloy with a transition temperature typically near 9 K in zero magnetic field.

**National Institute of Standards and Technology (NIST).** Government agency located in Gaithersburg, Maryland and Boulder, Colorado, that defines measurement standards in the United States.

**parts per million (ppm).**  $4 \times 10^{-6}$  is four parts per million.

**Percent (%).** The Model 241 can be configured to display the LHe level as a percentage. Normally, the low and high alarm setpoints are used to define 0% and 100%. Zero is used if the minimum alarm setpoint is undefined, and the active probe length is used if the maximum alarm setpoint is undefined.

**pounds per square inch (psi).** A unit of pressure. 1 psi = 6.89473 kPa. Variations include psi absolute (psia) measured relative to vacuum (zero pressure) where one atmosphere pressure equals 14.696 psia and psi gauge (psig) where gauge measured relative to atmospheric or some other reference pressure.

**prefixes.** SI prefixes used throughout this manual are as follows:

<u>Factor</u>	<u>Prefix</u>	<u>Symbol</u>	<u>Factor</u>	<u>Prefix</u>	<u>Symbol</u>
$10^{24}$	yotta	Y	$10^{-1}$	deci	d
$10^{21}$	zetta	Z	$10^{-2}$	centi	c
$10^{18}$	exa	E	$10^{-3}$	milli	m
$10^{15}$	peta	P	$10^{-6}$	micro	$\mu$
$10^{12}$	tera	T	$10^{-9}$	nano	n
$10^9$	giga	G	$10^{-12}$	pico	p
$10^6$	mega	M	$10^{-15}$	femto	f
$10^3$	kilo	k	$10^{-18}$	atto	a
$10^2$	hecto	h	$10^{-21}$	zepto	z
$10^1$	deka	da	$10^{-24}$	yocto	y

**Resistance Per Unit Length ( $\Omega/L$ ).** Resistance of a unit length of superconductive wire at a temperature where the is not superconducting. The Model 241 will work with sensors with an effective resistance range of 4 to 7  $\Omega/cm$  (1.6 to 2.8  $\Omega/in.$ ), to a maximum resistance of 350 $\Omega$ .

**RS-232C.** Bi-directional computer serial interface standard defined by the Electronic Industries Association (EIA). The interface is single-ended and non-addressable.

**Sample Period.** Time between level readings. On the Model 241, the time can be user defined from 0 to 19 hours 59 minutes, or turned off.

**setpoint.** The value selected to be maintained by an automatic controller.<sup>1</sup>

**serial interface.** A computer interface where information is transferred one bit at a time rather than one byte (character) at a time as in a parallel interface. RS-232C is the most common serial interface.

**SI.** Système International d'Unités. See International System of Units.

**temperature scales.** See Kelvin Scale, Celsius Scale, and ITS-90. Proper metric usage requires that only kelvin and degrees Celsius be used. However, since degrees Fahrenheit is in such common use, all three scales are delineated as follows:

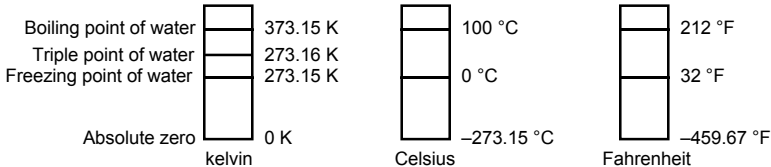

To convert kelvin to Celsius, subtract 273.15.

To convert Celsius to Fahrenheit: multiply  $^{\circ}C$  by 1.8 then add 32, or:  
 $^{\circ}F = (1.8 \times ^{\circ}C) + 32$ .

To convert Fahrenheit to Celsius: subtract 32 from  $^{\circ}F$  then divide by 1.8,  
 or:  $^{\circ}C = (^{\circ}F - 32) / 1.8$ .

**References:**

- 1 Sybil P. Parker, Editor. *Dictionary of Scientific and Technical Terms: Third Edition.* New York: McGraw Hill, 1969 (ISBN 0-395-20360-0)
- 2 Christopher J. Booth, Editor. *The New IEEE Standard Dictionary of Electrical and Electronic Terms: IEEE Std 100-1992, Fifth Edition.* New York: Institute of Electrical and Electronics Engineers, 1993 (ISBN 1-55937-240-0). Definitions printed with permission of the IEEE.
- 3 Nelson, Robert A. *Guide For Metric Practice*, Page BG7 - 8, Physics Today, Eleventh Annual Buyer's Guide, August 1994 (ISSN 0031-9228 coden PHTOAD)

## APPENDIX B

### HANDLING OF LIQUID HELIUM AND NITROGEN

#### B1.0 GENERAL

Liquid Helium (LHe) and liquid nitrogen (LN<sub>2</sub>) are often used in association with the Model 201/208 Digital Thermometer. Although not explosive, the following are safety considerations in the handling of LHe and LN<sub>2</sub>.

#### B2.0 PROPERTIES

LHe and LN<sub>2</sub> are colorless, odorless, and tasteless gases. Gaseous nitrogen makes up about 78% of the Earth's atmosphere, while helium comprises only about 5 ppm. Most helium is recovered from natural gas deposits. Once collected and isolated, gases will liquefy when properly cooled. Refer to Table B-1.

**Table B-1. Comparison of Liquid Helium to Liquid Nitrogen**

Property	LHe	LN <sub>2</sub>
Boiling Point @1 atm, in °K	4.2	77
Thermal Conductivity (Gas), w/cm-°K	0.083	0.013
Latent Heat of Vaporization, Btu/liter	2.4	152
Liquid Density, pounds/liter	0.275	0.78

#### B3.0 HANDLING CRYOGENIC STORAGE DEWARS

All cryogenic containers (dewars) must be operated in accordance with the manufacturer's instructions. Safety instructions will also be posted on the side of each dewar. Cryogenic dewars must be kept in a well-ventilated place where they are protected from the weather and away from any sources of heat.

#### B4.0 LIQUID HELIUM AND NITROGEN SAFETY PRECAUTIONS

Transferring LHe and LN<sub>2</sub> should be in accordance with the manufacturer/supplier's instructions. During the transfer, all safety precautions written on the storage dewar and recommended by the manufacturer must be followed.

**WARNING: Liquid helium and liquid nitrogen are potential asphyxiants and can cause rapid suffocation without warning. Store and use in area with adequate ventilation. DO NOT vent container in confined spaces. DO NOT enter confined spaces where gas may be present unless area has been well ventilated. If inhaled, remove to fresh air. If not breathing, give artificial respiration. If breathing is difficult, give oxygen. Get medical help.**

**WARNING: Liquid helium and liquid nitrogen can cause severe frostbite to the eyes or skin. DO NOT touch frosted pipes or valves. In case of frostbite, consult a physician at once. If a physician is not readily available, warm the affected areas with water that is near body temperature.**

The two most important safety aspects to consider when handling LHe and LN<sub>2</sub> are adequate ventilation and eye and skin protection. Although helium and nitrogen gases are non-toxic, they are dangerous in that they replace the air in a normal breathing atmosphere. Liquid products are of an even greater threat since a small amount of liquid evaporates to create a large amount of gas. Therefore, it is imperative that cryogenic dewars be stored and operated in open and well ventilated areas.

Persons transferring LHe and LN<sub>2</sub> should make every effort to protect eyes and skin from accidental contact with liquid or the cold gas issuing from it. Protect your eyes with full face shield or chemical splash goggles. Safety glasses (even with side shields) are not adequate. Always wear special cryogenic gloves (Tempshield Cryo-Gloves® or equivalent) when handling anything that is, or may have been, in contact with the liquid or cold gas, or with cold pipes or equipment. Long sleeve shirts and cuffless trousers that are of sufficient length to prevent liquid from entering the shoes are recommended.

## **B5.0 RECOMMENDED FIRST AID**

Every site that stores and uses LHe and LN<sub>2</sub> should have an appropriate Material Safety Data Sheet (MSDS) present. The MSDS may be obtained from the manufacturer/distributor. The MSDS will specify the symptoms of overexposure and the first aid to be used. A typical summary of these instructions is provided as follows.

If symptoms of asphyxia such as headache, drowsiness, dizziness, excitation, excess salivation, vomiting, or unconsciousness are observed, remove the victim to fresh air. If breathing is difficult, give oxygen. If breathing has stopped, give artificial respiration. Call a physician immediately.

If exposure to cryogenic liquids or cold gases occurs, restore tissue to normal body temperature (98.6 °F) as rapidly as possible, then protect the injured tissue from further damage and infection. Call a physician immediately. Rapid warming of the affected parts is best achieved by bathing it in warm water. The water temperature should not exceed 105 °F (40 °C), and under no circumstances should the frozen part be rubbed, either before or after rewarming. If the eyes are involved, flush them thoroughly with warm water for at least 15 minutes. In case of massive exposure, remove clothing while showering with warm water. The patient should not drink alcohol or smoke. Keep warm and rest. Call a physician immediately.

## APPENDIX C

### CURVE TABLES

#### C1.0 GENERAL

The following curve tables are applicable to the Model 201/208 Digital Thermometer. Curve 0 (DT-500DI-8B) is detailed in Table C-1, Curve 1 (DT-500DI-8A) in Table C-2, Curve 2 (DT-500DRC-D) in Table C-3, Curve 3 (DT-500DRC-E1) in Table C-4, Curve 4 (CTI Curve C) in Table C-5, Curve 5 (DT-500DI-8C) in Table C-6, and Curve 6 (DT-470 Curve 10) in Table C-7.

**Table C-1. Curve 0 - DT-500DI-8B Voltage-Temp. Characteristics**

BP #	Temp. (K)	PROM Voltage	BP #	Temp. (K)	PROM Voltage	BP #	Temp. (K)	PROM Voltage		
29	4.0	2.41773	19	29.0	1.11353	7	170.0	0.73733		
	4.2	2.40475		18	30.0		1.10729	175.0	0.72353	
	4.4	2.39217		17	32.0		1.09810	180.0	0.70936	
	4.6	2.37946		16	34.0		1.09125	185.0	0.69532	
	4.8	2.36668		15	36.0		1.08547	190.0	0.68125	
	5.0	2.35378			38.0		1.08038	195.0	0.66713	
	5.5	2.32126		14	40.0		1.07549	200.0	0.65302	
	6.0	2.28869			45.0		1.06400	205.0	0.63889	
	6.5	2.25643		13	50.0		1.05273	210.0	0.62475	
	7.0	2.22480			55.0		1.04123	215.0	0.61066	
	7.5	2.19395		12	60.0		1.02954	6	220.0	0.59646
	8.0	2.16053			65.0		1.01748		225.0	0.58262
	28	8.5		2.13552	11		70.0	1.00528	230.0	0.56877
		9.0		2.10809			75.0	0.99263	235.0	0.55504
9.5		2.08197		77.4	0.98666	5	240.0	0.54136		
10.0		2.05687	80.0	0.97988	245.0		0.52801			
11.0		2.00852	10	85.0	0.96711	250.0	0.51469			
12.0		1.96003		90.0	0.95397	4	255.0	0.50155		
13.0		1.90579	95.0	0.94086	260.0		0.48815			
27		14.0	1.85614	100.0	0.92767	265.0	0.47486			
		15.0	1.80479	105.0	0.91443	270.0	0.46148			
26		16.0	1.74703	9	110.0	0.90124	275.0	0.44800		
	17.0	1.67479	115.0		0.88776	3	280.0	0.43451		
	18.0	1.60665	120.0	0.87434	285.0		0.42064			
	19.0	1.53675	125.0	0.86087	290.0	0.40675				
	20.0	1.46370	130.0	0.84735	295.0	0.39274				
	21.0	1.38832	135.0	0.83377	2	300.0	0.37875			
	22.0	1.31868	8	140.0		0.82032	305.0	0.36436		
23.0	1.26476	145.0		0.80647	310.0	0.35002				
24	24.0	1.21712	150.0	0.79274	315.0	0.33559				
23	25.0	1.17857	155.0	0.77896	320.0	0.32109				
22	26.0	1.15106	160.0	0.76513	325.0	0.30656				
21	27.0	1.13317	165.0	0.75125	1	330.0	0.29222			
20	28.0	1.12169								

**Table C-2. Curve 1 - DT-500DI-8A Voltage-Temp. Characteristics**

BP #	Temp. (K)	PROM Voltage	BP #	Temp. (K)	PROM Voltage	BP #	Temp. (K)	PROM Voltage	
30	4.0	2.46386	17	29.0	1.11741	7	170.0	0.72739	
	4.2	2.44821	16	30.0	1.11007		175.0	0.71308	
	4.4	2.43188	15	32.0	1.09942		180.0	0.69891	
	4.6	2.41500	14	34.0	1.09178		185.0	0.68469	
	4.8	2.39781	13	36.0	1.08559		190.0	0.67043	
29	5.0	2.37578	12	38.0	1.07992	195.0	0.65615		
	5.5	2.33823		40.0	1.07502	200.0	0.64185		
	6.0	2.29906		45.0	1.06307	205.0	0.62754		
	6.5	2.26440		50.0	1.05136	210.0	0.61333		
28	7.0	2.23248	11	55.0	1.03951	6	215.0	0.59901	
	7.5	2.20480		60.0	1.02744		220.0	0.58502	
	8.0	2.17716		65.0	1.01475		225.0	0.57099	
	8.5	2.14994		70.0	1.00193		230.0	0.55715	
27	9.0	2.12245	10	75.0	0.98892	5	235.0	0.54327	
	9.5	2.10065		77.4	0.98264		240.0	0.52983	
	10.0	2.07844		80.0	0.97557		245.0	0.51639	
	11.0	2.03712		85.0	0.96216		250.0	0.50302	
	12.0	1.99736		90.0	0.94877		255.0	0.48965	
	13.0	1.95641		9	95.0		0.93535	260.0	0.47625
26	14.0	1.91202	100.0	0.92166	4	265.0	0.46292		
	15.0	1.85236		105.0		0.90798	270.0	0.44925	
	16.0	1.79177		110.0		0.89426	275.0	0.43559	
	17.0	1.73193		115.0		0.88052	280.0	0.42178	
25	18.0	1.66870	120.0	0.86676	3	285.0	0.40797		
	19.0	1.59215		125.0		0.85298	290.0	0.39375	
	20.0	1.51169		8		130.0	0.83936	295.0	0.37951
	21.0	1.43234		135.0		0.82531	300.0	0.36515	
24	22.0	1.34993	140.0	0.81142	2	305.0	0.35078		
23	23.0	1.28434	145.0	0.79749		310.0	0.33599		
22	24.0	1.23212	150.0	0.78351	315.0	0.32121			
21	25.0	1.18995	155.0	0.76950	320.0	0.30643			
20	26.0	1.16027	160.0	0.75544	325.0	0.29159			
19	27.0	1.14015	165.0	0.74135	1	330.0	0.27665		
18	28.0	1.12689							

**Table C-3. Curve 2 - DT-500DRC-D Voltage-Temp. Characteristics**

BP #	Temp. (K)	PROM Voltage	BP #	Temp. (K)	PROM Voltage	BP #	Temp. (K)	PROM Voltage	
30	1.4	2.5984	24	21.0	1.3505	8	180.0	0.70757	
	1.5	2.5958		22.0	1.3006		185.0	0.69344	
	1.6	2.5932	23	23.0	1.2507		190.0	0.67931	
	1.7	2.5906		24.0	1.2114		195.0	0.65518	
	1.8	2.5880	22	25.0	1.1720		200.0	0.65105	
	1.9	2.5854	21	26.0	1.1486		205.0	0.63693	
	2.0	2.5828	20	27.0	1.1308		210.0	0.62280	
	2.2	2.5735	19	28.0	1.1190		215.0	0.60867	
	2.4	2.5643	18	29.0	1.1116		220.0	0.59455	
	2.6	2.5551	17	30.0	1.1058		225.0	0.58080	
29	2.8	2.5458	16	32.0	1.0970	7	230.0	0.56707	
	3.0	2.5366	15	34.0	1.0902		235.0	0.55334	
	3.2	2.5226		36.0	1.0850		240.0	0.53960	
	3.4	2.5086		38.0	1.0798		245.0	0.52649	
	3.6	2.4946	14	40.0	1.0746		250.0	0.51337	
	3.8	2.4807		45.0	1.0633		255.0	0.50026	
	4.0	2.4667		50.0	1.0520		260.0	0.48714	
	4.2	2.4527	13	55.0	1.0407		6	265.0	0.47403
	4.4	2.4387		60.0	1.0287			270.0	0.46057
	4.6	2.4247		65.0	1.0166		275.0	0.44711	
4.8	2.4108	12	70.0	1.0046	280.0	0.43365			
5.0	2.3968		75.0	0.99172	5	285.0	0.42019		
5.5	2.3618		80.0	0.97890		290.0	0.40613		
6.0	2.3269		85.0	0.96609	295.0	0.39208			
6.5	2.2919	11	90.0	0.95327	4	300.0	0.37802		
7.0	2.2570		95.0	0.93987		305.0	0.36397		
7.5	2.2220		100.0	0.92647	310.0	0.34940			
8.0	2.1871		105.0	0.91307	315.0	0.33482			
8.5	2.1521		110.0	0.89966	320.0	0.32025			
28	9.0	2.1172		115.0	0.88626	325.0	0.30568		
	9.5	2.0909		120.0	0.87286	330.0	0.29111		
	10.0	2.0646		125.0	0.85946	335.0	0.27654		
	11.5	2.0119	10	130.0	0.84606	340.0	0.26197		
	12.0	1.9592		135.0	0.83228	3	345.0	0.24739	
13.0	1.9066		140.0	0.81850	350.0		0.23325		
14.0	1.8338		145.0	0.80472	355.0	0.21911			
26	15.0	1.7610		150.0	0.79094	360.0	0.20497		
16.0	1.6984		155.0	0.77716	2	365.0	0.19083		
17.0	1.6359		160.0	0.76338		370.0	0.17774		
25	18.0	1.5646		165.0	0.74961	375.0	0.16464		
	19.0	1.4932	9	170.0	0.73582	1	380.0	0.15155	
	20.0	1.4219		175.0	0.72170				

**Table C-4. Curve 3 - DT-500DRC-E1 Voltage-Temp. Characteristics**

BP #	Temp. (K)	PROM Voltage	BP #	Temp. (K)	PROM Voltage	BP #	Temp. (K)	PROM Voltage
30	1.4	2.6591		18.0	1.6527		145.0	0.8035
	1.5	2.6567		19.0	1.5724		150.0	0.7896
	1.6	2.6542		20.0	1.4922		155.0	0.7758
	1.7	2.6518		21.0	1.4120		160.0	0.7620
	1.8	2.6494		22.0	1.3317		165.0	0.7482
29	1.9	2.6470		23.0	1.2837	7	170.0	0.7344
	2.0	2.6446		24.0	1.2357		175.0	0.7202
	2.2	2.6355	21	25.0	1.1877		180.0	0.7060
	2.4	2.6265	20	26.0	1.1559		185.0	0.6918
	2.6	2.6175	19	27.0	1.1365		190.0	0.6777
28	2.8	2.6084	18	28.0	1.1239		195.0	0.6635
	3.0	2.5994	17	29.0	1.1150		200.0	0.6493
	3.2	2.5868	16	30.0	1.1080		205.0	0.6351
	3.4	2.5742	15	32.0	1.0981		210.0	0.6210
	3.6	2.5616	14	34.0	1.0909		215.0	0.6068
27	3.8	2.5490	13	36.0	1.0848	6	220.0	0.5926
	4.0	2.5364		38.0	1.0797		225.0	0.5789
	4.2	2.5221	12	40.0	1.0746		230.0	0.5651
	4.4	2.5077		45.0	1.0630		235.0	0.5514
	4.6	2.4934		50.0	1.0515		240.0	0.5377
4.8	2.4791	55.0		1.0399	245.0	0.5246		
5.0	2.4648	11		60.0	1.0284	250.0	0.5115	
5.5	2.4290		65.0	1.0159	255.0	0.4984		
6.0	2.3932		70.0	1.0035	260.0	0.4853		
6.5	2.3574		75.0	0.9911	4	265.0	0.4722	
7.0	2.3216		77.35	0.9849		270.0	0.4588	
7.5	2.2858	80.0	0.9780	275.0		0.4454		
8.0	2.2500	85.0	0.9649	280.0		0.4320		
8.5	2.2142	90.0	0.9518	3		285.0	0.4186	
26	9.0	2.1784	95.0		0.9388	290.0	0.4045	
	9.5	2.1516	9		100.0	0.9257	295.0	0.3904
	10.0	2.1247			105.0	0.9122	300.0	0.3763
	11.0	2.0708			110.0	0.8988	2	305.0
	12.0	2.0170		115.0	0.8853	310.0		0.3476
25	13.0	1.9632		120.0	0.8718	315.0		0.3330
	14.0	1.9011	125.0	0.8584	320.0	0.3184		
	15.0	1.8390	8	130.0	0.8449	325.0		0.3038
	16.0	1.7769		135.0	0.8311	1	330.0	0.2893
	17.0	1.7148		140.0	0.8173			



**Table C-5. Curve 4 - CTI Diode Voltage-Temp. Characteristics**

BP #	Temp. (K)	PROM Voltage	BP #	Temp. (K)	PROM Voltage	BP #	Temp. (K)	PROM Voltage
29	10.0	1.4000		55.0	1.0235		190.0	0.6545
28	11.0	1.3850	21	60.0	1.0100	8	195.0	0.6408
27	12.0	1.3656	20	65.0	0.9958		200.0	0.6270
	13.0	1.3400		70.0	0.9822		205.0	0.6133
26	14.0	1.3161		75.0	0.9690		210.0	0.5995
	15.0	1.2750	19	77.4	0.9626		215.0	0.5858
	16.0	1.2350		80.0	0.9560		220.0	0.5720
	17.0	1.1910	18	85.0	0.9440		225.0	0.5583
25	18.0	1.1500	17	90.0	0.9314		230.0	0.5445
24	19.0	1.1290	16	95.0	0.9184		235.0	0.5308
23	20.0	1.1162	15	100.0	0.9049		240.0	0.5170
	21.0	1.1135		105.0	0.8907		245.0	0.5032
	22.0	1.1109	14	110.0	0.8769	7	250.0	0.4896
	23.0	1.1084	13	115.0	0.8625		255.0	0.4757
	24.0	1.1058		120.0	0.8500		260.0	0.4620
	25.0	1.1033	12	125.0	0.8376		265.0	0.4481
	26.0	1.1007	11	130.0	0.8245	6	270.0	0.4341
	27.0	1.0981		135.0	0.8109		275.0	0.4197
	28.0	1.0955	10	140.0	0.7971	5	280.0	0.4050
	29.0	1.0929		145.0	0.7828	4	285.0	0.3911
	30.0	1.0903		150.0	0.7685		290.0	0.3775
	32.0	1.0851		155.0	0.7543	3	295.0	0.3640
	34.0	1.0799		160.0	0.7400		300.0	0.3510
22	36.0	1.0747	9	165.0	0.7255	2	305.0	0.3382
	38.0	1.0693		170.0	0.7114		310.0	0.3243
	40.0	1.0640		175.0	0.6972		315.0	0.3106
	45.0	1.0505		180.0	0.6830	1	320.0	0.2968
	50.0	1.0370		185.0	0.6690			

**Table C-6. Curve 5 - DT-500DI-8C Voltage-Temp. Characteristics**

BP #	Temp. (K)	PROM Voltage	BP #	Temp. (K)	PROM Voltage	BP #	Temp. (K)	PROM Voltage	
29	4.0	2.6187	23	24.0	1.2317	7	135.0	0.8377	
	4.2	2.6074		22	25.0		1.1900	140.0	0.8243
	4.4	2.5956		21	26.0		1.1602	145.0	0.8108
	4.6	2.5834		20	27.0		1.1402	150.0	0.7974
	4.8	2.5709		19	28.0		1.1269	155.0	0.7837
28	5.0	2.5580	18	29.0	1.1173	6	160.0	0.7701	
	5.2	2.5484		17	30.0		1.1100	165.0	0.7564
	5.4	2.5312		16	31.0		1.1039	170.0	0.7427
	5.6	2.5173			32.0		1.0991	175.0	0.7289
	5.8	2.5033		15	33.0		1.0949	180.0	0.7152
27	6.0	2.4890	14	34.0	1.0913	5	185.0	0.7013	
	6.5	2.4524		14	35.0		1.0879	190.0	0.6874
	7.0	2.4151			36.0		1.0850	195.0	0.6734
	7.5	2.3773			37.0		1.0822	200.0	0.6595
	8.0	2.3394		13	38.0		1.0795	205.0	0.6455
26	8.5	2.2976	12	39.0	1.0770	4	210.0	0.6315	
	9.0	2.2643			40.0		1.0746	215.0	0.6176
	9.5	2.2277			42.0		1.0697	220.0	0.6036
	10.0	2.1919			44.0		1.0649	225.0	0.5898
	10.5	2.1566			46.0		1.0603	230.0	0.5761
25	11.0	2.1221	11	48.0	1.0558	3	235.0	0.5625	
	11.5	2.0881			50.0		1.0512	240.0	0.5490
	12.0	2.0545			52.0		1.0467	245.0	0.5358
	12.5	2.0211			54.0		1.0421	250.0	0.5226
	13.0	1.9875			56.0		1.0376	255.0	0.4096
24	13.5	1.9537	10	58.0	1.0330	2	260.0	0.4966	
	14.0	1.9193			60.0		1.0285	265.0	0.4836
	14.5	1.8843			65.0		1.0168	270.0	0.4705
	15.0	1.8480			70.0		1.0049	275.0	0.4574
	15.5	1.8110			75.0		0.9930	280.0	0.4442
23	16.0	1.7748	9	77.4	0.9870	1	285.0	0.4307	
	16.5	1.7441			80.0		0.9805	290.0	0.4171
	17.0	1.7047			85.0		0.9680	295.0	0.4035
	17.5	1.6702			90.0		0.9553	300.0	0.3898
	18.0	1.6361			95.0		0.9427	305.0	0.3758
22	18.5	1.6022	8	100.0	0.9297		310.0	0.3618	
	19.0	1.5676			105.0		0.9168	315.0	0.3477
	19.5	1.5316			110.0		0.9038	320.0	0.3336
	20.0	1.4950			115.0		0.8907	325.0	0.3194
	21.0	1.4218			120.0		0.8777	330.0	0.3054
21	22.0	1.3461		125.0	0.8643				
	23.0	1.2840		130.0	0.8510				

**Table C-7. Curve 6 – DT-470 Voltage-Temperature Characteristics**

BP #	Temp. (K)	PROM Voltage	BP #	Temp. (K)	PROM Voltage	BP #	Temp. (K)	PROM Voltage		
29	1.4	1.69808	25	12.0	1.36687	13	70.0	1.03425		
	1.5	1.69674		12.5	1.35647		75.0	1.02482		
	1.6	1.69521		13.0	1.34530		77.4	1.02044		
	1.7	1.69355		13.5	1.33453		80.0	1.01525		
	1.8	1.69177		14.0	1.32412		85.0	1.00552		
28	1.9	1.68987	24	14.5	1.31403	12	90.0	0.99565		
	2.0	1.68912		15.0	1.30422		95.0	0.98574		
	2.1	1.68574		15.5	1.29340		100.0	0.97550		
	2.2	1.68352		16.0	1.28527		105.0	0.96524		
	2.3	1.68121		16.5	1.27607		110.0	0.95487		
	2.4	1.67880		17.0	1.26702		11	115.0	0.94455	
	2.5	1.67632		17.5	1.25810			120.0	0.93383	
	2.6	1.67376		18.0	1.24928			125.0	0.92317	
	2.7	1.67114		18.5	1.24053			130.0	0.91243	
	2.8	1.66845		19.0	1.23184			135.0	0.90161	
27	2.9	1.66571	23	19.5	1.22314	10	140.0	0.89082		
	3.0	1.66292		20.0	1.21555		145.0	0.87976		
	3.1	1.66009		21.0	1.19645		150.0	0.86873		
	3.2	1.65721		22.0	1.17705		155.0	0.85764		
	3.3	1.65430		23.0	1.15558		160.0	0.84650		
	3.4	1.65134		22	24.0	1.13598	9	165.0	0.83541	
	3.5	1.64833			21	25.0		1.12463	170.0	0.82404
	3.6	1.64529			20	26.0		1.11896	175.0	0.81274
	3.7	1.64219			19	27.0		1.11517	180.0	0.80138
	3.8	1.64112			18	28.0		1.11202	185.0	0.78999
26	3.9	1.63587	17	29.0	1.10945	8	190.0	0.77855		
	4.0	1.63263		30.0	1.10702		195.0	0.76717		
	4.2	1.62602		31.0	1.10465		200.0	0.75554		
	4.4	1.61920		32.0	1.10263		205.0	0.74398		
	4.6	1.61220		33.0	1.10060		210.0	0.73238		
	4.8	1.60506		34.0	1.09864	215.0	0.72075			
	5.0	1.59782		35.0	1.09675	220.0	0.70908			
	5.2	1.59047		16	36.0	1.09477	225.0	0.69737		
	5.4	1.58303			37.0	1.09309	7	230.0	0.68580	
	5.6	1.57551			38.0	1.09131		235.0	0.67387	
5.8	1.56792	39.0	1.08955		240.0	0.66208				
6.0	1.56027	40.0	1.08781		245.0	0.65026				
6.5	1.54097	42.0	1.08436	250.0	0.63841					
26	7.0	1.52166	15	44.0	1.08105	6	255.0	0.62654		
	7.5	1.50272		46.0	1.07748		260.0	0.61465		
	8.0	1.48443		48.0	1.07402		265.0	0.60273		
	8.5	1.46700		50.0	1.07053		270.0	0.59080		
	9.0	1.44850		52.0	1.06700		275.0	0.57886		
	9.5	1.43488		54.0	1.06346	280.0	0.56707			
	10.0	1.42013		56.0	1.05988	285.0	0.55492			
	10.5	1.40615		58.0	1.05629	290.0	0.54294			
	11.0	1.39287		14	60.0	1.05277	295.0	0.53093		
	11.5	1.38021			65.0	1.04353	300.0	0.51892		

**Table C-7. Curve 6 - DT-470 Voltage-Temp Characteristics (Continued)**

BP #	Temp. (K)	PROM Voltage	BP #	Temp. (K)	PROM Voltage	BP #	Temp. (K)	PROM Voltage
	305.0	0.50689		365.0	0.36110		425.0	0.21212
	310.0	0.49484		370.0	0.34881		430.0	0.19961
	315.0	0.48278		375.0	0.33650	3	435.0	0.18696
	320.0	0.47069		380.0	0.32416		440.0	0.17464
	325.0	0.45858		385.0	0.31180		445.0	0.16221
	330.0	0.44647	4	390.0	0.29958		450.0	0.14985
	335.0	0.43435		395.0	0.28700		455.0	0.13759
5	340.0	0.42238		400.0	0.27456	2	460.0	0.12536
	345.0	0.41003		405.0	0.26211		465.0	0.11356
	350.0	0.39783		410.0	0.24963		470.0	0.10191
	355.0	0.38561		415.0	0.23714	1	475.0	0.09032
	360.0	0.37337		420.0	0.22463			

## ∞ NOTES ∞

## ***Lake Shore***

is a technology leader in the development of cryogenic temperature sensors, precision low temperature measurement and control instrumentation, and magnetic measurement and test systems. Since 1968, Lake Shore physicists, material scientists, and engineers have dedicated themselves to the development of tomorrow's technology today. Lake Shore serves a worldwide network of Customers including university and national laboratories, aerospace and other industries, as well as many of the premier companies around the world.